

ADVERTIMENT. La consulta d'aquesta tesi queda condicionada a l'acceptació de les següents condicions d'ús: La difusió d'aquesta tesi per mitjà del servei TDX (www.tesisenxarxa.net) ha estat autoritzada pels titulars dels drets de propietat intel·lectual únicament per a usos privats emmarcats en activitats d'investigació i docència. No s'autoritza la seva reproducció amb finalitats de lucre ni la seva difusió i posada a disposició des d'un lloc aliè al servei TDX. No s'autoritza la presentació del seu contingut en una finestra o marc aliè a TDX (framing). Aquesta reserva de drets afecta tant al resum de presentació de la tesi com als seus continguts. En la utilització o cita de parts de la tesi és obligat indicar el nom de la persona autora.

ADVERTENCIA. La consulta de esta tesis queda condicionada a la aceptación de las siguientes condiciones de uso: La difusión de esta tesis por medio del servicio TDR (www.tesisenred.net) ha sido autorizada por los titulares de los derechos de propiedad intelectual únicamente para usos privados enmarcados en actividades de investigación y docencia. No se autoriza su reproducción con finalidades de lucro ni su difusión y puesta a disposición desde un sitio ajeno al servicio TDR. No se autoriza la presentación de su contenido en una ventana o marco ajeno a TDR (framing). Esta reserva de derechos afecta tanto al resumen de presentación de la tesis como a sus contenidos. En la utilización o cita de partes de la tesis es obligado indicar el nombre de la persona autora.

WARNING. On having consulted this thesis you're accepting the following use conditions: Spreading this thesis by the TDX (www.tesisenxarxa.net) service has been authorized by the titular of the intellectual property rights only for private uses placed in investigation and teaching activities. Reproduction with lucrative aims is not authorized neither its spreading and availability from a site foreign to the TDX service. Introducing its content in a window or frame foreign to the TDX service is not authorized (framing). This rights affect to the presentation summary of the thesis as well as to its contents. In the using or citation of parts of the thesis it's obliged to indicate the name of the author

**IFMIF ACCELERATOR FACILITY RAMI ANALYSES
IN THE ENGINEERING DESIGN PHASE**

Enric Bargalló Font

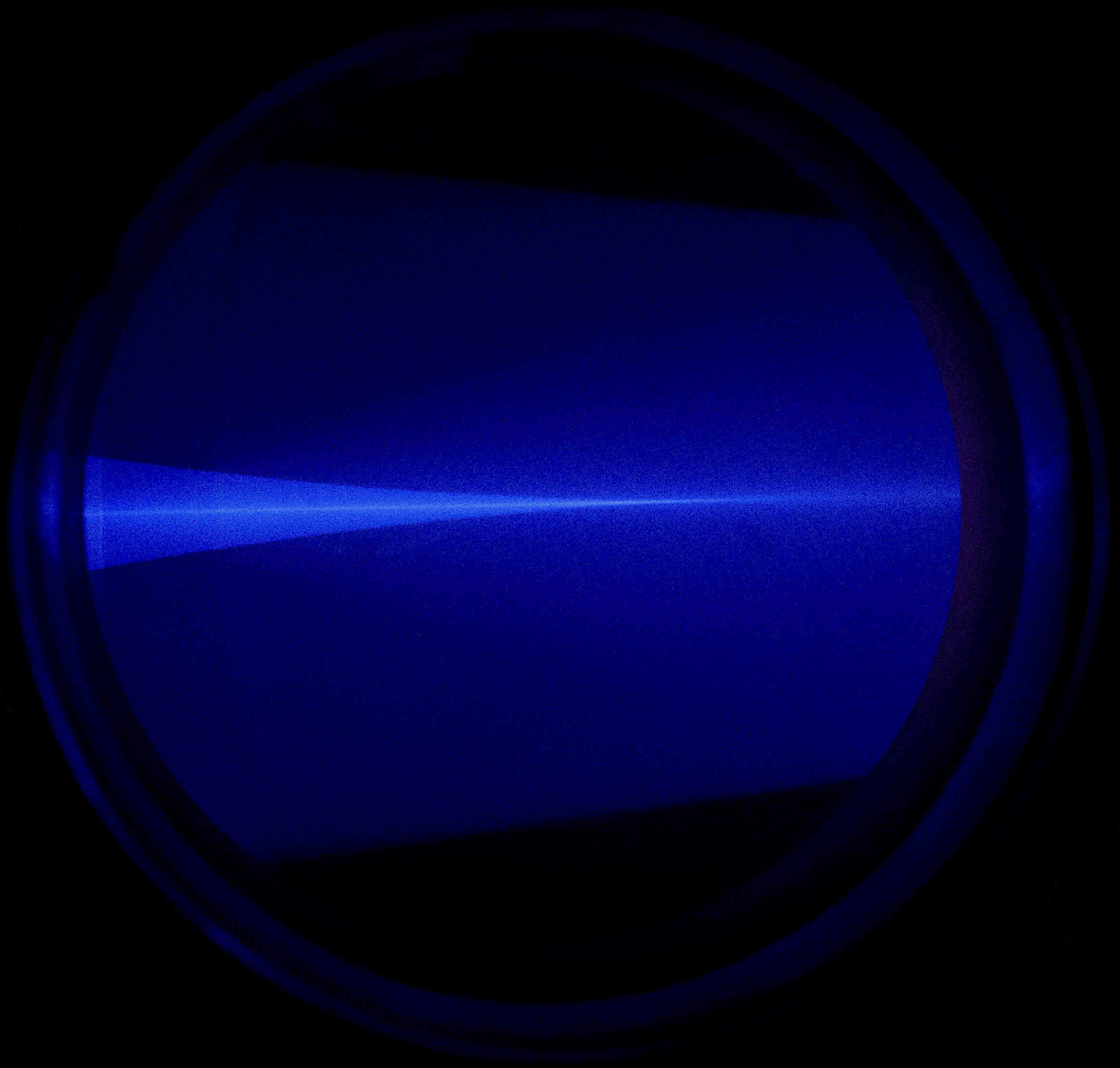



Departament de Física i Enginyeria Nuclear
Escola Tècnica Superior d'Enginyeria Industrial de Barcelona
UNIVERSITAT POLITÈCNICA DE CATALUNYA



Fusion Energy Engineering Laboratory
Nuclear Engineering Research Group

IFMIF ACCELERATOR FACILITY RAMI ANALYSES IN THE ENGINEERING DESIGN PHASE

Ph.D. Thesis presented by

ENRIC BARGALLÓ FONT

for the Doctor's degree at the Universitat Politècnica de Catalunya

February 2014

Directors

Dr. Javier Dies Llovera
Dr. Carlos Tapia Fernández

Abstract

The planned International Fusion Materials Irradiation Facility (IFMIF) has the mission to test and qualify materials for future fusion reactors. IFMIF will employ the deuterium-lithium stripping reaction to irradiate the test samples with a high-energy neutron flux. IFMIF will consist mainly of two linear deuteron accelerators, a liquid lithium loop and a test cell. Accelerated deuterons will collide with the lithium producing a high-energy neutron flux that will irradiate the material samples in the test cell.

A timely and relevant fusion neutron source is essential in the path towards DEMO and future fusion power plants. For this reason, IFMIF is required to have high availability to obtain a fusion materials database to find suitable materials for DEMO design within the anticipated timeline. RAMI (Reliability Availability Maintainability Inspectability) analyses are being performed in the very early stages of design to meet such requirements.

The IFMIF accelerator facility is composed of two independent linear accelerators, each of which produces a 40 MeV, 125 mA deuteron beam in a continuous wave mode at 175 MHz. These beam characteristics pose several unprecedented challenges: the highest beam intensity, the highest space charge, the highest beam power and the longest RFQ (Radio Frequency Quadrupole). As a result of these challenges, many design characteristics are counter to high-availability performance: the design is reluctant to accept failures, machine protection systems are likely to stop the beam undesirably, cryogenic components require long periods for maintenance, and activation of components complicates maintenance activities. These design difficulties, together with the high availability requirements and the demanding scheduled operational periods, make RAMI analysis an essential tool in the engineering design phase.

These studies were performed in collaboration with system designers, enabling the creation of RAMI models that reflect current accelerator design. This feedback has been of the utmost importance to propose plausible design modifications in order to improve the availability performance of the machine. Parallel activity on the design and construction of the Linear IFMIF Prototype Accelerator (LIPAc) provided the detailed design information needed to conduct these studies properly.

An iterative process was followed to match IFMIF design and availability studies. These iterations made it possible to include recommendations and design change proposals coming from the RAMI analyses into the accelerator reference design. Iterations consist of gathering information from the design, creating or updating the RAMI models, obtaining and analyzing results, and proposing ways to improve the design.

Three different approaches were carried out in the iterative process. First, a comparison with other similar facilities was performed. Second, an individual fault tree analysis was developed for each system of the accelerator. Finally, a Monte Carlo simulation was performed for the whole accelerator facility considering synergies between systems. These approaches make it possible to go from detailed hardware availability analyses to global accelerator performance, to identify weak design points, and to propose design alternatives as well as foresee IFMIF performance, maintenance and operation characteristics.

The IFMIF accelerator facility design was analyzed from the RAMI point of view, estimating its future availability and guiding the design towards a high reliability and availability performance. In order to achieve the high-availability requirements several design changes have already been included in the accelerator reference design whereas other important design modifications have been proposed and will be further analyzed in future design phases.

Framework

This thesis has been carried out according to an agreement between the UPC (Polytechnic University of Catalonia) and CIEMAT (Centro de Investigaciones Energéticas, Medioambientales y Tecnológicas) to develop RAMI (Reliability, Availability, Maintainability, and Inspectability) analyses for the IFMIF (International Fusion Materials Irradiation Facility) project.

The IFMIF project is part of the Fusion Broader Approach Agreement signed by Euratom and Japan. CIEMAT is one of the European collaborating institutes, and is in charge of the Spanish work packages for the IFMIF project. One of these packages was part of the RAMI analyses of IFMIF.

The IFMIF RAMI team was composed of a RAMI coordinator and a RAMI officer for each facility (Accelerator, Target, Test and Conventional). As part of the IFMIF RAMI team, I have been in charge of the IFMIF Accelerator Facility RAMI analyses (as the Accelerator Facility RAMI Officer) from 2010 to 2013. My involvement in the project allowed me to be in the proper environment to enhance the quality of these studies.

Although the accelerator designers and experts belong to different countries and institutes, a close relationship was achieved thanks to continuous email and telephone contact as well as regular videoconference and in-person meetings. Also, I attended specific RAMI workshops and IFMIF generic workshops (Spain in 2010, Japan in 2011 and Italy in 2012). Moreover, I did a two-week visit at CEA-Saclay institute (France) in January 2013 with several IFMIF accelerator designers.

I have received a Polytechnic University of Catalonia PhD Scholarship from 2010 to 2014 and two Spanish Nuclear Safety Council travel grants (one for the Accelerator Reliability Workshop 2011 in Cape Town, South Africa and another for the CEA-Saclay visit).

Declaration

The content of this thesis have been internally documented and reviewed by the IFMIF RAMI team, accelerator experts and the project team over the last several years. The main documents are:

- IFMIF RAMI Specifications, December 2011
- Accelerator facility RAMI analysis for the Detailed Design Document first-phase (DDD-I) design, January 2012
- Accelerator facility RAMI analysis for the Detailed Design Document second-phase (DDD-II) design, November 2012
- Accelerator facility RAMI analysis for the Detailed Design Document third-phase (DDD-III) design, May 2013
- Intermediate IFMIF Engineering Design Report (IIEDR), June 2013

An external quality review panel analyzed the IIEDR document and made particular mention of the high quality of the RAMI analyses section.

The majority of the work and results shown in this thesis have been published in the following papers:

“RAM methodology and activities for IFMIF engineering design”

J.M. Arroyo, A. Ibarra, J. Molla, J. Abal, E. Bargalló, J. Dies, C. Tapia
Proceedings of the 2nd International Particle Accelerator Conference (2011)
<http://accelconf.web.cern.ch/AccelConf/IPAC2011/papers/thps060.pdf>

“RAMI analyses of the IFMIF accelerator facility and first availability allocation between systems”

E. Bargalló, G. Martinez, J.M. Arroyo, J. Abal, P.-Y. Beauvais, F. Orsini, R. Gobin, M. Weber, I. Podadera, D. Regidor, J. Calvo, A. Giralt, J. Dies, C. Tapia, A. De Blas, A. Ibarra, J. Molla
Fusion Engineering and Design (2012), DOI: 10.1016/j.fusengdes.2012.11.014

“Availability, reliability and logistic support studies of the RF power system design options for the IFMIF accelerator”

E. Bargalló, A. Giralt, G. Martinez, M. Weber, D. Regidor, J.M. Arroyo, J. Abal, J. Dies, C. Tapia, A. De Blas, P. Mendez, A. Ibarra, J. Molla

Fusion Engineering and Design (2013), DOI: 10.1016/j.fusengdes.2013.01.016

“IFMIF RAMI analyses in the Engineering Design Phase”

E. Bargalló, J.M. Arroyo, J. Abal, J. Dies, C. Tapia, A. De Blas, A. Ibarra, J. Molla
Proceedings of the International Conference on Emerging Nuclear Energy Systems (2013)

“Hardware availability calculations and results of the IFMIF accelerator facility”

E. Bargalló, J.M. Arroyo, J. Abal, P.-Y. Beauvais, R. Gobin, F. Orsini, M. Weber, I. Podadera, F. Grespan, E. Fagotti, J. Dies, C. Tapia, A. De Blas, J. Molla, A. Ibarra
Fusion Engineering and Design (2014) (publication accepted)

“Availability simulation software adaptation to the IFMIF accelerator facility RAMI analysis”

E. Bargalló, P.J. Sureda, J.M. Arroyo, J. Abal, A. De Blas, J. Dies, C. Tapia, J. Molla, A. Ibarra

Fusion Engineering and Design (2014), DOI: 10.1016/j.fusengdes.2013.12.004

Moreover, I have collaborated in other publications related to the IFMIF RAMI analyses:

“RAMI strategies in the IFMIF Test Facilities design”

J. Abal, J. Dies, J.M. Arroyo, E. Bargalló, N. Casal, Á. García, D. Español, G. Martínez, C. Tapia, A. De Blas, J. Mollá, Á. Ibarra

Fusion Engineering and Design (2013) DOI: 10.1016/j.fusengdes.2013.04.003

“RAMI analysis in IFMIF remote handled operations”

J. Abal, J. Dies, E. Baeza, J.M. Arroyo, E. Bargalló, A. García, C. Tapia, A. De Blas, J. Mollá, A. Ibarra

Fusion Engineering and Design (paper submitted)

“RAMI status in the IFMIF Test facilities at the end of the engineering design phase”

J. Abal, J. Dies, J.M. Arroyo, E. Bargalló, A. García, N. Casal, A. Mas, C. Tapia, A. De Blas, J. Mollá, A. Ibarra

Fusion Engineering and Design (paper submitted)

These studies have permitted me to impart and contribute to several communications in different conferences, workshops and scientific events:

"IFMIF RAMI modelization work"

J. Abal, E. Bargalló, J. Dies, C. Tapia, A. Ibarra

3th International Fusion Material Irradiation Facility Workshop. Madrid, Spain. September 2010.

"Exploration of reliability databases and comparison of former IFMIF's results"

C. Tapia, J. Dies, J. Abal, A. Ibarra, J.M. Arroyo, E. Bargalló

26th Symposium on Fusion Technology. Porto, Portugal. September 2010.

"IFMIF accelerator: Database, FMEA, fault tree and RAM"

C. Tapia, J. Dies, V. Pesudo, J. Abal, A. Ibarra, J.M. Arroyo, E. Bargalló

26th Symposium on Fusion Technology. Porto, Portugal. September 2010.

"Accelerator RAMI analysis: first iteration results"

E. Bargalló, J. Abal, J. M. Arroyo, J. Dies, C. Tapia, A. De Blas, J. Mollá, A. Ibarra

4th International Fusion Material Irradiation Facility Workshop. Naka, Japan. December 2011.

"RAMI methodology and activities for IFMIF engineering design"

E. Bargalló, J. Abal, J. M. Arroyo, J. Dies, C. Tapia, A. De Blas, J. Mollá, A. Ibarra

Accelerator reliability Workshop. Cape town, South Africa. April 2011.

"Integration of RAMI in the engineering design phase"

J. Abal, J. M. Arroyo, E. Bargalló, J. Dies, C. Tapia, A. De Blas, J. Mollá, A. Ibarra

Laser Mega Joule and IFMIF RAMI workshop. Bordeaux, France, February 2011.

"RAM approach for IFMIF"

J. M. Arroyo, E. Bargalló, J. Abal, J. Dies, C. Tapia, A. De Blas, J. Mollá, A. Ibarra

Laser Mega Joule and IFMIF RAMI workshop. Bordeaux, France, February 2011.

"IFMIF RAMI Work: reliability data"

J. Abal, J. Dies, E. Bargalló, C. Tapia, A. De Blas

IEA Task 5 workshop: Fusion reliability database. Barcelona, Spain. January 2011.

"IFMIF Accelerator Facility RAMI analysis"

E. Bargalló, J. Abal, J. M. Arroyo, J. Dies, C. Tapia, A. De Blas, J. Mollá, A. Ibarra

5th International Fusion Material Irradiation Facility Workshop. Bologna, Italy. November 2012.

"RF system solid state alternative: RAMI analysis"

E. Bargalló, J. Abal, J. M. Arroyo, J. Dies, C. Tapia, A. De Blas, J. Mollá, A. Ibarra
5th International Fusion Material Irradiation Facility Workshop. Bologna, Italy.
November 2012.

"RAMI activities in the Test facilities"

J. Abal, J. M. Arroyo, E. Bargalló, J. Dies, C. Tapia, A. De Blas, J. Mollá, A. Ibarra
5th International Fusion Material Irradiation Facility Workshop. Bologna, Italy.
November 2012.

"IFMIF RAMI studies overview"

J. M. Arroyo, E. Bargalló, J. Abal, J. Dies, C. Tapia, A. De Blas, J. Mollá, A. Ibarra
5th International Fusion Material Irradiation Facility Workshop. Bologna, Italy.
November 2012.

"RAMI analyses of the IFMIF accelerator facility and first availability allocation between systems"

E. Bargalló, G. Martinez, J.M. Arroyo, J. Abal, P.-Y. Beauvais, F. Orsini, R. Gobin, M. Weber, I. Podadera, D. Regidor, J. Calvo, A. Giralt, J. Dies, C. Tapia, A. De Blas, A. Ibarra, J. Molla
27th Symposium on Fusion Technology. Liège, Belgium. September 2012.

"Availability, reliability and logistic support studies of the RF power system design options for the IFMIF accelerator"

E. Bargalló, A. Giralt, G. Martinez, M. Weber, D. Regidor, J.M. Arroyo, J. Abal, J. Dies, C. Tapia, A. De Blas, P. Mendez, A. Ibarra, J. Molla
27th Symposium on Fusion Technology. Liège, Belgium. September 2012.

"RAMI strategies in the IFMIF Test Facilities design"

J. Abal, J. Dies, J.M. Arroyo, E. Bargalló, N. Casal, Á. García, D. Español, G. Martínez, C. Tapia, A. De Blas, J. Mollá, Á. Ibarra
27th Symposium on Fusion Technology. Liège, Belgium. September 2012.

"RAMI analysis of IFMIF"

J. M. Arroyo, E. Bargalló, J. Abal, J. Dies, C. Tapia, A. De Blas, J. Mollá, A. Ibarra
International Workshop on Reliability Engineering in Scientific Installations. Madrid, Spain. September 2012.

"IFMIF Accelerator Facility RAMI Analyses in the engineering design phase"

E. Bargalló, J.M. Arroyo, J. Abal, J. Dies, C. Tapia, A. De Blas, A. Ibarra, J. Molla
International Conference on Emerging Nuclear Energy Systems, Madrid, Spain, 26-30
May 2013.

“RAMI analysis of IFMIF”

E. Bargalló, J. M. Arroyo, J. Abal, P. J. Sureda, E. Baeza, J. Molla, A. Ibarra, C. Tapia, J. Dies.

Superconducting Linacs for High Power Proton Beams (SLHiPP-3), Louvain-La-Neuve, Belgium, 17-18 April 2013.

“IFMIF RAMI analysis: developing a high-availability oriented design”

J. M. Arroyo, E. Bargalló, J. Abal, J. Mollá, A. Ibarra, C. Tapia, J. Dies

4th Accelerator Reliability Workshop. Melbourne, Australia. April 2013.

“Solid State alternative for the LIPAc and IFMIF RF Power Systems”

M. Weber, P. Méndez, I. Kirpitchenov, D. Regidor, A. Lara, C. de la Morena, E. Bargalló, J.M. Arroyo, J. Molla, A. Ibarra

4th International Particle Accelerator Conference. Shanghai, China. May 2013.

“IFMIF RAMI analyses in the Engineering Design Phase”

E. Bargalló, J.M. Arroyo, J. Abal, J. Dies, C. Tapia, A. De Blas, A. Ibarra, J. Molla

International Conference on Emerging Nuclear Energy Systems, Madrid, May 2013.

“RAMI analysis in IFMIF remote handled operations”

J. Abal, J. Dies, E. Baeza, J.M. Arroyo, E. Bargalló, A. García, C. Tapia, A. De Blas, J. Mollá, A. Ibarra

International Symposium on Fusion Nuclear Technology, Barcelona, September 2013.

“RAMI status in the IFMIF Test facilities at the end of the engineering design phase”

J. Abal, J. Dies, J.M. Arroyo, E. Bargalló, A. García, N. Casal, A. Mas, C. Tapia, A. De Blas, J. Mollá, A. Ibarra

International Symposium on Fusion Nuclear Technology, Barcelona, September 2013.

“Hardware availability calculations and results of the IFMIF accelerator facility”

E. Bargalló, J.M. Arroyo, J. Abal, P.-Y. Beauvais, R. Gobin, F. Orsini, M. Weber, I. Podadera, F. Grespan, E. Fagotti, J. Dies, C. Tapia, A. De Blas, J. Molla, A. Ibarra

International Symposium on Fusion Nuclear Technology, Barcelona, September 2013.

“Availability simulation software adaptation to the IFMIF accelerator facility RAMI analysis”

E. Bargalló, P.J. Sureda, J.M. Arroyo, J. Abal, A. De Blas, J. Dies, C. Tapia, J. Molla, A. Ibarra

International Symposium on Fusion Nuclear Technology, Barcelona, September 2013.

Acknowledgements

I am extremely grateful to Prof. Javier Dies for giving me the opportunity to pursue my PhD in this subject and in such an excellent environment to develop my professional career. I wish to thank Profs. Carlos Tapia and Alfredo de Blas for their advice and counsel during these years.

This thesis could never have been completed without Jose Manuel Arroyo and Javier Abal. Thank you both so much for your guidance and patience throughout this process. I have learned a lot at your side.

I wish to also acknowledge the contributions and commitment of Gonzalo Martinez, Pere Joan Sureda and Albert Giralt to the analyses conducted in this thesis though their final degree projects and master theses.

I would like to express my deep gratitude to all IFMIF members and collaborators from CIEMAT, CEA, ENEA, KIT, JAEA and the IFMIF PT for the help and contributions they have made to these analyses. Special thanks to Pierre-Yves Beauvais for his kindness, hospitality and counsel during my visit to CEA Saclay.

I would also like to express my special thanks to Professor Thomas Himel from Stanford University for allowing us to use and adapt the AvailSim software and for his advice and assistance.

Gràcies als companys de la universitat per aconseguir amenitzar els dies de feina. Trobaré molt a faltar la tradicional hora del cafè amb vosaltres.

Vull expressar el meu infinit agraïment als meus familiars i amics, però especialment als meus pares pel seu suport en tot moment.

Finalment, Helena, vull expressar la felicitat i vitalitat que em dona tenir-te al meu costat, ho ets tot per mi.

Contents

Chapter 1 – Introduction.....	7
1.1 Nuclear Fusion	7
1.2 Nuclear fusion approaches and devices	9
1.3 International Fusion Materials Irradiation Facility	11
1.3.1 <i>Damage production and neutron spectrum</i>	11
1.3.2 <i>IFMIF operation principle and facilities</i>	13
1.3.3 <i>Main IFMIF requirements</i>	14
1.3.4 <i>IFMIF phases and history</i>	15
1.4 RAMI concepts	16
1.4.1 <i>Reliability</i>	17
1.4.2 <i>Availability</i>	17
1.4.3 <i>Maintainability</i>	18
1.4.4 <i>Inspectability</i>	19
1.5 RAMI analyses for IFMIF	19
1.5.1 <i>Previous analyses</i>	20
1.5.2 <i>IFMIF RAMI Requirements</i>	20
Chapter 2 – Purpose of the thesis	23
Chapter 3 – State of the art.....	25
3.1 IFMIF accelerators	25
3.2 RAMI analyses in particle accelerators.....	27
3.2.1 <i>International Linear Collider (ILC)</i>	28
3.2.2 <i>Accelerator-Driven Systems (ADS)</i>	29
Chapter 4 – IFMIF accelerator design	31
4.1 Accelerator facility main requirements	32
4.2 Beam dynamics implication in the design	32
4.3 Plant distribution.....	33
4.4 Accelerator design description for each system	34
4.4.1 <i>Injector</i>	34
4.4.2 <i>RFQ</i>	36
4.4.3 <i>MEBT</i>	38
4.4.4 <i>SRF linac</i>	39

Contents

4.4.5 HEBT	40
4.4.6 Beam dump	42
4.4.7 Diagnostics	42
4.4.8 RF power system	42
4.4.9 Accelerator ancillary systems	44
4.5 Design evolution	45
Chapter 5 – RAMI methodology	47
5.1 Iterative process	47
5.2 Comparative analysis	49
5.3 Probabilistic calculations	50
5.4 Availability simulation	50
5.5 Other RAMI tools and analyses	51
5.6 Description of the methodology used in the analyses	51
Chapter 6 – Accelerator facility RAMI definitions	53
6.1 Specific accelerator definitions	53
6.2 Other parameters definitions	55
Chapter 7 – Accelerator facility availability requirements	57
7.1 Accelerator facility top requirements	57
7.2 Availability distribution	58
7.3 Preliminary beam effectiveness estimation	58
7.4 Availability requirements and allocation	59
7.4.1 Hardware availability requirement	59
7.4.2 Hardware availability allocation	59
Chapter 8 – Hypotheses and assumptions	61
8.1 Operation and maintenance assumptions	61
8.2 Analysis assumptions	62
8.3 Mean Down-time assumptions	63
8.3.1 Detection time	63
8.3.2 Location: Access time, cooling time	64
8.3.3 Components: MTTRepair, MTTReplace, Logistics	64
8.3.4 System to recover: Recover Time + Tuning Time	64
8.3.5 Turn-on sequence	65
8.4 Generic design assumptions	66
8.4.1 Water cooling systems	66
8.4.2 Power supplies	66
8.4.3 Control system	66
8.5 Reliability data used	67
8.6 Uncertainties	68
8.7 Failure acceptance and beam degradation	69
8.7.1 Operation limits	70
8.7.2 Failures per system	71
8.7.3 Summarizing table	75
8.7.4 Multiple failures	76

8.7.5 Other failure acceptance issues.....	77
8.7.6 Beam degradation and failure acceptance conclusions.....	77
Chapter 9 – Comparison with other facilities.....	79
9.1 Availability in other facilities.....	79
9.2 Operation and maintenance plans in other facilities.....	82
9.3 Beam trips data gathering and extrapolation to IFMIF.....	83
9.3.1 Data gathering.....	84
9.3.2 Important parameters for the trip rate.....	86
9.3.3 Extrapolation to IFMIF.....	86
9.3.4 Beam trips’ unavailability contribution.....	88
9.3.5 Beam trips conclusions.....	89
9.4 SFR linac: data gathering and comparison with IFMIF.....	89
9.4.1 Introduction.....	90
9.4.2 Relevant aspects for availability calculation.....	90
9.4.3 Operational data from other facilities.....	91
9.4.4 Design and complexity comparison of SRF systems.....	92
9.4.5 Comparison calculation and results of cryomodule refurbishments.....	93
9.4.6 Design optimization in terms of RAMI.....	94
9.4.7 SRF linac comparison conclusions.....	94
Chapter 10 – Probabilistic analyses.....	95
10.1 Injector.....	96
10.1.1 Comparison with other Injectors.....	96
10.1.2 Model description.....	97
10.1.3 Assumptions.....	98
10.1.4 Probabilistic analysis and results.....	100
10.1.5 Injector RAMI analysis conclusions.....	103
10.2 Radio Frequency Quadrupole.....	104
10.2.1 Model description.....	104
10.2.2 Assumptions.....	105
10.2.3 Probabilistic analysis and results.....	109
10.2.4 RFQ RAMI analysis conclusions.....	109
10.3 MEBT.....	110
10.3.1 Model description.....	110
10.3.2 Assumptions.....	111
10.3.3 Probabilistic analysis and results.....	112
10.3.4 MEBT RAMI analysis conclusions.....	113
10.4 SRF linac.....	114
10.4.1 Model description.....	114
10.4.2 Assumptions.....	115
10.4.3 Probabilistic analysis and results.....	117
10.4.4 SFR linac RAMI analysis conclusions.....	124
10.5 HEBT.....	124
10.5.1 Model description.....	125
10.5.2 Assumptions.....	125
10.5.3 Probabilistic analysis and results.....	127
10.5.4 HEBT RAMI analysis conclusions.....	129
10.6 Diagnostics.....	129

Contents

10.6.1 Model description.....	130
10.6.2 Assumptions	131
10.6.3 Probabilistic analysis and results.....	131
10.6.4 Diagnostics RAMI analysis conclusions	132
10.7 RF system	132
10.7.1 Model description.....	133
10.7.2 Assumptions and data used	133
10.7.3 Probabilistic analysis and results.....	134
10.7.4 RF system conclusions	141
10.8 Accelerator facility auxiliary systems	142
10.9 RiskSpectrum results and conclusions.....	143
Chapter 11 – Availability simulation.....	147
11.1 Why a simulation?.....	147
11.2 AvailSim 1.0.....	148
11.3 How does AvailSim 2.0 work?	148
11.4 AvailSim 2.0 new features	149
11.4.1 Data and inputs.....	149
11.4.2 Functions and parameters.....	150
11.4.3 Simulation iterations	151
11.4.4 Outputs.....	151
11.4.5 Other changes and improvements	152
11.5 Software validation	152
11.5.1 Basic simulation tests.....	152
11.5.2 Enhanced features verification.....	152
11.5.3 Comparison with former IFMIF analyses.....	152
11.6 Beam parameter evolution example.....	153
11.7 AvailSim 2.0 results	155
11.7.1 Reference design results.....	155
11.7.2 Improved design results	156
11.7.3 AvailSim results and conclusions.....	158
Chapter 12 – Summary and conclusions	161
12.1 Summary of the analyses and final results	161
12.2 Conclusions	163
12.3 Goals achieved	164
12.4 Future work and recommendations.....	166
Appendix A – RAMI analysis description	169
A.1 PBS example	169
A.2 Basic component’s functions.....	170
A.3 FMEA	171
A.4 Model inputs.....	171
A.5 RiskSpectrum model	173
A.6 AvailSim model	175
A.7 Results	177

References 179
Acronyms 189

Chapter 1

Introduction

The world today is facing the formidable challenge of finding a way to guarantee future energy sources that are not only economically but also environmentally and socially acceptable. Despite the technological difficulties that they pose, nuclear fusion reactors have been postulated as an excellent future energy source [1]. Studies carried out for the European Commission [2] support this point of view due to their intrinsically safety, inexhaustibility, cleanliness, lack of direct radioactive waste generation and no production of long-term radioactive decommissioning waste. Furthermore, they make no contribution to the greenhouse effect or to the destruction of the ozone layer and cause no acid rain [3]. All of these features make nuclear fusion an excellent candidate as a future source of energy.

1.1 Nuclear Fusion

The reaction by which two or more atomic nuclei join together to form a new and heavier atomic nucleus is called nuclear fusion. This reaction is usually produced between two light nuclei generating a heavier nucleus. In this process, the mass is not conserved; thus, following Einstein's equation $E=mc^2$ [4], the mass loss is converted into energy.

The electrostatic repulsion force between the positively charged nuclei must be surpassed in order to allow the strong attractive nuclear force to join them together. The Coulomb barrier is the minimum energy required in order to overcome the electrostatic repulsion. To surpass this barrier, nuclei have to collide at high velocities. Therefore, if nuclei kinetic energies are higher than a certain level, they can get close enough to be attracted by the strong force to be bound together.

Among the possible nucleolus reactions, the deuterium-tritium reaction has been identified as the most efficient due to its better cross-section at lower energies (Figure 1.1). Therefore, it is planned that the first future fusion power reactors will use these two hydrogen isotopes.

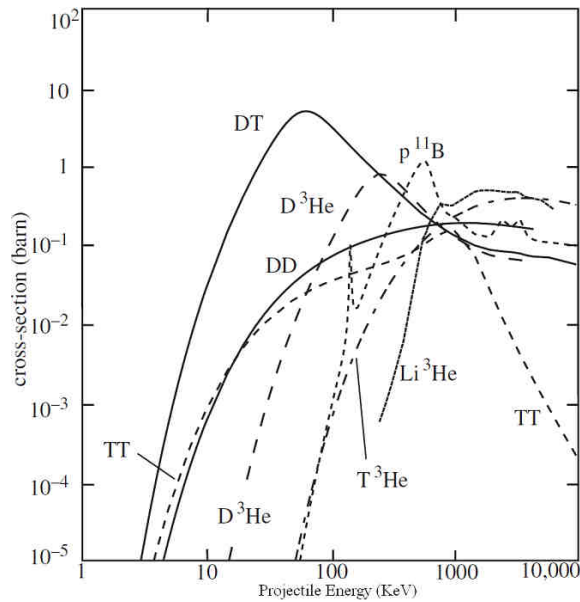

Figure 1.1 – Cross-sections of different fusion reactions [5]

The deuterium-tritium reaction joins together the ^2H and ^3H nucleus to generate a helium (^4He) nuclei and a neutron (Figure 1.2). The energy of the reaction is balanced by the kinetic energy of the products, where the major part is taken by the neutron (14.1 MeV) and the rest by the helium nuclei (3.5 MeV).

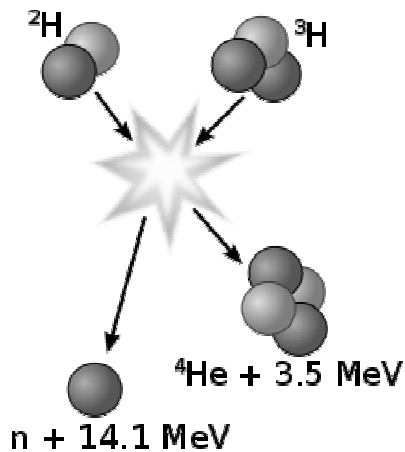
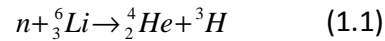

Figure 1.2 – Deuterium-tritium fusion reaction

Deuterium can be found in abundance on Earth. On the other hand, tritium is extremely rare in nature due to its half-life of 12.3 years; however, tritium can be obtained using the reaction between lithium and the neutrons produced in the fusion reaction (Eq. 1.1). A self-sufficient tritium production at the plant could be possible by means of neutron multipliers such as lead [6].



Other possible reactions will be considered once the deuterium-tritium reaction is fully controlled and the technology is sufficiently mature. Other reactions could have some benefits such as the lack of a need for tritium or the ability to generate protons instead of neutrons; however, the energy needed to achieve these reactions is higher and thus is not currently under consideration.

To achieve a self-sustained fusion reaction, it is necessary to achieve a minimum required value of the product of three parameters: density, temperature and confinement time. This criterion is defined in Equation 1.2 and was defined by John D. Lawson [7].

$$n_e \cdot T \cdot \tau_e \geq 10^{21} \frac{\text{KeV} \cdot \text{s}}{\text{m}^3} \quad (1.2)$$

This reaction is continuously occurring in the stars due to an enormous triple product value; however, achieving an acceptable Lawson criterion in an artificial fusion reactor device is a real challenge. Much scientific and technological progress has been achieved, but there is still a long way to go before profitable fusion power plants can be connected to the electric grid.

1.2 Nuclear fusion approaches and devices

To achieve nuclear fusion, there are two main approaches: inertial confinement and magnetic confinement. The inertial option consists of heating and compressing a deuterium and tritium mixture pellet target by means of laser, electron or ion beams. The magnetic confinement approach is based on confining a hot deuterium and tritium plasma through magnetic fields. The magnetic approach is considered to be more promising, and it is currently more developed than the other. Among the different magnetic approach design options, the Tokamak concept has become the dominant device in fusion research and has been chosen to develop the next experimental fusion machines.

Research and development work has been conducted for the last 60 years, and hundreds of facilities have been built around the world [8]. The Japanese JT-60, at Naka, achieved the highest value of fusion triple product of any device [9]. Tore Supra, in Cadarache, holds the record for the longest plasma duration time on a Tokamak – more

than 6 minutes [10]. The Joint European Torus, in the United Kingdom, has the energy release record of 70% of the input power [11]. These achievements have led the fusion science and technology to the threshold of the plasma energy breakeven point, which is the moment when plasma releases as much energy as that which is required to produce it. The project that is expected to achieve this is called 'ITER' (International Thermonuclear Experimental Reactor). This experimental facility will produce more power than it consumes: for 50 MW of input power, 500 MW of output power will be produced.

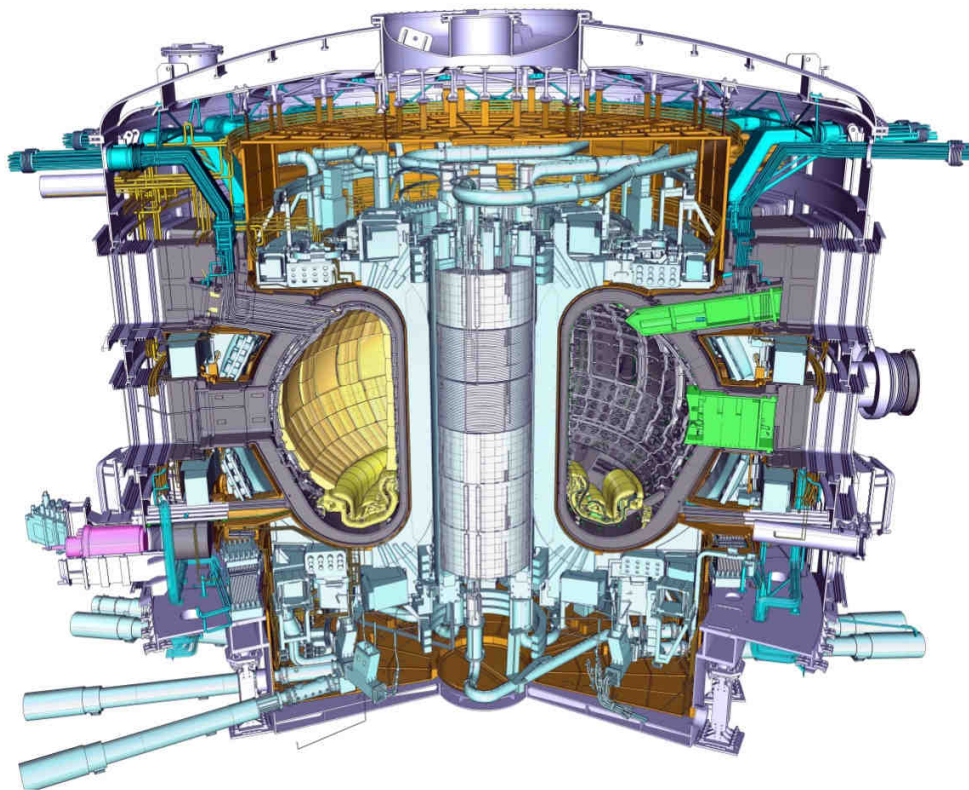

Figure 1.3 – Detailed model of the ITER Tokamak. Image Credit: ITER Organization 2011

Several key milestones must be achieved before the design and construction of a commercial fusion power plant. For this reason, the current international fusion development scenario is considering the achievement of these milestones through three different projects: the qualification of the fusion reactor physics in ITER, the validation of materials for in-vessel components in IFMIF (International Fusion Materials Irradiation Facility) and the qualification of components and processes in DEMO (DEMONstration Power Plant) [12].

ITER results and IFMIF-validated data are essential for the final design and safety assessment and will serve as the basis for the reliable operation and lifetime evaluation of DEMO components. Data generated from IFMIF are needed and expected within the same

timeframe as results from ITER operation [13]. Currently, ITER is under construction at Cadarache (France), IFMIF is in the engineering design and validation phase, and DEMO is in the pre-conceptual design phase.

1.3 International Fusion Materials Irradiation Facility

The first wall of the future fusion reactor will face an extreme irradiation environment caused by a high flux of 14 MeV neutrons generated by the nuclear fusion reaction. ITER, as an experimental facility, will be operative only for a few short periods each year and the expected damage to its first wall materials will be low. However, for DEMO and for a commercial fusion reactor power plant, the development of materials capable of withstanding such neutron fluxes is mandatory. The development and validation of these materials in IFMIF are on the critical path for early use of fusion power [14].

The planned IFMIF has the mission to test and qualify these materials for the design and construction of DEMO and the future Fusion Power Plant. The main requirement for this neutron source is to produce a fusion characteristic neutron spectrum with enough intensity to allow accelerated testing and with an irradiation volume large enough to permit the characterization of the macroscopic properties of materials. At present, there is no appropriate irradiation test facility that can adequately simulate the fusion environment [15].

1.3.1 Damage production and neutron spectrum

Inelastic collisions of neutrons with the nuclei of the structural materials will transmute heavy nuclei, which can decay releasing protons and α -particles. In addition, elastic collisions will induce ion displacements, the so-called “displacements per atom” (dpa). Those effects will clearly degrade and impoverish the properties of the materials.

Under the same neutron bombardment, different materials will present different dpa as well as H and He generation. Moreover, inside the reactor vessel, materials will be exposed to different fluxes and spectrums of neutrons. Moreover, time evolution of radiation damage in the materials, such as recombination, migration, and coalescence of lattice defects, should be considered. In summary, the high-energy neutrons produce structural defects in the material and nuclear reactions, giving rise to transmutation of the material. Unfortunately, detailed information on these effects, which is needed for the engineering design of DEMO as well as a fusion reactor, is missing [13].

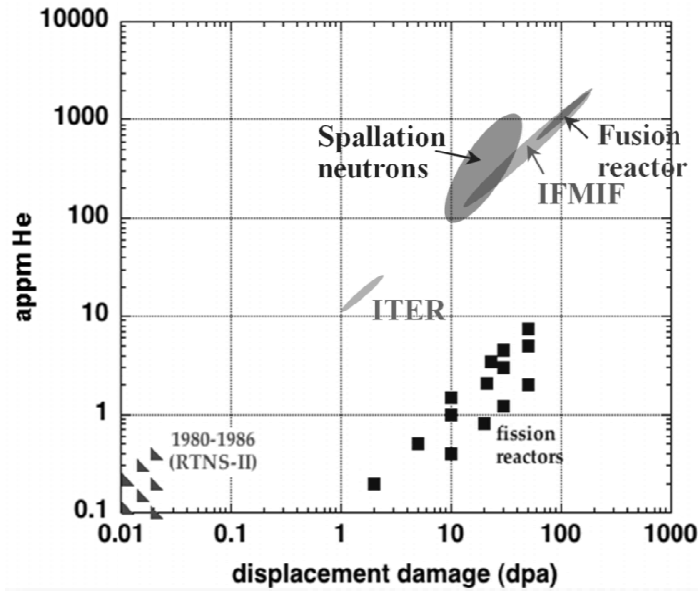

Figure 1.4 – He and displacement damage levels for current and future facilities [16]

As can be seen in Figure 1.4, ITER and fission reactors are some orders of magnitude below the expected damage caused to fusion reactor materials. Spallation neutron sources get quite close to the required He generation, but do not produce enough dpa. IFMIF will be able to generate an environment for material samples with dpa and He generation similar to the ones that the future fusion reactors materials will have to endure.

Facility	Displacement damage rate (dpa/fpy)	He (appm/dpa)	H (appm/dpa)
DEMO 1 st Wall, 3.5 MW/m ²	30	11	41
IFMIF high flux test module	20-55	10-12	35-54
HRF fission reactor, pos. F8	2.5	0.3	0.8
HFIR fission reactor, RB	9	0.2	-
HFIR fission reactor, target	24	0.35	5
BOR60 fast reactor, pos. D23	20	0.29	0.7
ESS spallation source, reflector	5-10	5-6	33-36
ESS spallation source, target hull	20-33	25-30	250-300
SNS spallation source FMITS, 5 cm	5	20	100
SNS spallation source FMITS, 3 cm	10	75	310
SINQ spallation source, center rod 1	≤10	≤70	≤470
MTS spallation, fuel positions, 15 cm	17.5	29	-
MTS spallation, fuel positions, 5 cm	32	16	-

Table 1.1 – Summary of ferritic/martensitic steel irradiation parameters, including damage rate per full power year (fpy), for several current and proposed neutron irradiation facilities [17]

Irradiation parameters for current and proposed neutron irradiation facilities are shown in Table 1.1. It might seem that spallation sources could be used for fusion material studies, but their large neutron tails (Figure 1.5) and the possible problems related to pulsed irradiation effects are a real concern [17].

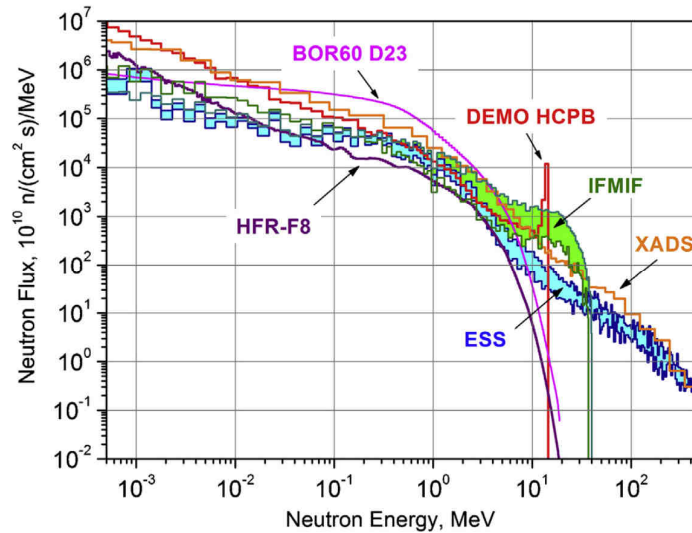

Figure 1.5 – He neutron energy spectrum for several facilities [17]

IFMIF test specimens will be placed in different modules inside the test cell. The neutron fluxes in these modules are compared with those expected in DEMO and other facilities in Figure 1.5. As this figure shows, the expected DEMO neutron energy spectrum will be similar to that of the IFMIF.

1.3.2 IFMIF operation principle and facilities

Adequate high-energy neutron irradiation will be provided by colliding accelerated deuteron ions with a lithium target, where the deuteron-lithium stripping reaction will occur. The generated neutrons will then be used to irradiate material specimens placed in the test modules inside the IFMIF test cell. Besides the common and conventional facilities, IFMIF will be mainly composed of three facilities:

- **Accelerator Facility:** Two linear high-power accelerators (5 MW each) accelerate 125 mA of deuterons at 40 MeV in a continuous wave (100% duty cycle) each. Both beams are shaped in a flat-top distribution of 200 x 50 mm².
- **Target Facility:** The beams impinge on a liquid lithium curtain (25 mm thick) at about 15 m/s. The 10 MW beam heat has to be removed by the high-speed lithium flow.
- **Test Facility:** The high neutron flux will impact the test modules. The principal ones are the high, medium and low flux test modules. Modules' structures

must be exchanged from time to time. All maintenance must be done by a complex remote handling system.

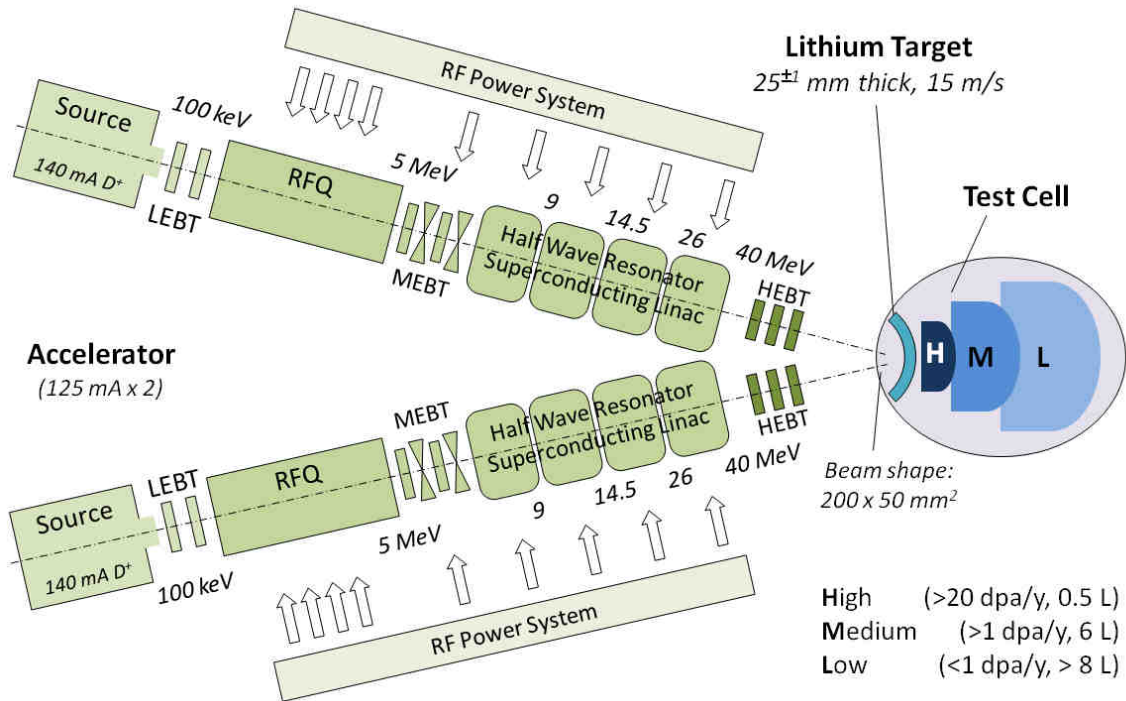

Figure 1.6 – IFMIF schematic view of the two accelerators, the lithium target and the test cell

Many challenges must be addressed in the three facilities. First, the accelerator will be the most powerful of its kind (explained in Chapter 3). Secondly, the operation of a liquid lithium loop in very specific conditions with high availability requirements is extremely challenging. Finally, the test facility will have to resist an unparalleled neutron flux with very reliable conditions.

1.3.3 Main IFMIF requirements

In order to achieve the IFMIF goals in the fusion roadmap, three top requirements were extracted from previous IFMIF documents [15,18].

- Neutron energy: a broad energy peak near 14 MeV
- Neutron flux: 10^{18} n·s·m⁻² at the high flux test module
- Machine availability: 70% of the time

Other requirements – such as sufficient volume for 1,000 test samples [14], good accessibility of irradiation volume for experimentation, and instrumentation – must be also considered.

As can be seen, together with neutron fluencies, irradiation volume and other user requirements, the IFMIF facility must be available for at least 70% of the time in order to produce a displacement damage rate high enough to obtain the fusion materials database on a time scale consistent with anticipated DEMO construction.

Availability analyses had to be done during each IFMIF design phase in order to ensure that the design considers this important aspect and that the final facility performance achieves the high availability requirements.

1.3.4 IFMIF phases and history

From 1990 to 2006, IFMIF was a joint effort of the European Union, Japan, the Russian Federation, and the United States within the framework of the Fusion Materials Implementing Agreement of the International Energy Agency.

During the Conceptual Design Activity (CDA) phase (1995-1996), a reference conceptual design [18] was developed for IFMIF. That design was the basis for the Conceptual Design Evaluation (CDE) phase (1997-1998) [19]. In 1999, a review of the IFMIF design was requested, focusing on cost reduction [20,21]. Between 2000 and 2002, the reduction of some key technology risk factors was carried out in the Key Element Technology Phase (KEP) [22]. Finally, in 2004, the Comprehensive Conceptual Design Report (CDR) [15] was produced, summarizing the technology level and the estimated costs of the major systems based on the results of the CDA, CDE and KEP phases.

The Broader Approach (BA) agreement between EU and Japan for fusion research signed in 2006, agreed to three main projects. One of these projects was IFMIF's EVEDA phase, the main objective of which was "to produce a detailed, complete, and fully integrated engineering design of the International Fusion Materials Irradiation Facility and all data necessary for future decisions on the construction, operation, exploitation and decommissioning of IFMIF and to validate continuous and stable operation of each IFMIF subsystem" [23]. That included the full construction and operation of prototypes at a relevant scale to validate some critical aspects of the IFMIF design (2007-2017). Moreover, it included the production of the Intermediate IFMIF Engineering Design Report (IIEDR) in 2013 [13].

One of these prototypes consists of constructing and operating the low-energy section (up to 9 MeV) of one of the IFMIF accelerators (Figure 1.7) [24]. This accelerator is

called LIPAc (Linear IFMIF Prototype Accelerator) and is being constructed in Rokkasho, Japan.

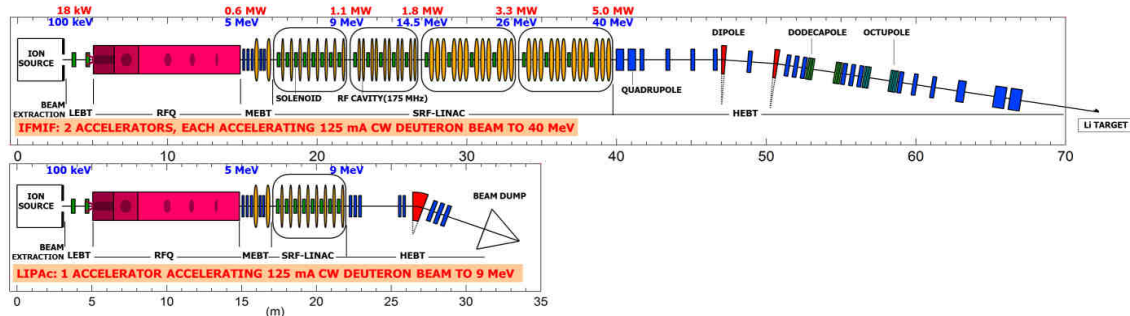

Figure 1.7 – General layout of the IFMIF and LIPAc accelerators

LIPAc will have the same beam parameters as in the first part of the IFMIF accelerators (up to the first cryomodule). LIPAc beam power will be 1,125 kW, while for IFMIF it will be 5,000 kW. This prototype will be used to validate the feasibility of IFMIF accelerators.

1.4 RAMI concepts

RAMI stands for ‘Reliability, Availability, Maintainability and Inspectability’. This concept is an evolution of dependability, RAMS (Reliability, Availability, Maintainability and Safety), RAM (Reliability, Availability and Maintainability) and reliability analyses using similar tools and methodologies and following similar goals. RAMI studies do not evaluate safety considerations but take into account all parameters that contribute to achieve better operation and maintenance performances.

These studies use several tools and methodologies to estimate, calculate, improve and collect data about the performance of a system or machine regarding operation, failures and repairs. RAMI engineering comprises all activities done through the design, construction, commissioning, testing and exploitation of a system related to improve its RAMI performances.

In the design phases, RAMI analyses are used to foresee the future operation of the machine using its design and operational information together with operational and probabilistic failure data gathered from other machines. The design is analyzed and modified to improve its performance. Depending on the goal of the machine, one or more parameters could be optimized. For example, for a machine whose goal is to be operative for as long as possible without failures, the goal will be to achieve high reliability performance. On the other hand, if the goal is to produce as much as possible in a determinate period of time, then its objective will be high availability.

Improving the availability of a system is not the same as improving its reliability. A reliable system has a small number of failures with long amounts of time between them. A good availability performance means that the total downtime of the system is small compared to its operation time. In other words, a large number of failures could occur, as long as they do not shut down the machine for too long. In this last case, the only important parameter is the total downtime. Maintainability and inspectability are used to achieve high reliability and availability levels.

In the following sub-chapters, basic RAMI concepts are explained.

1.4.1 Reliability

Reliability is related to the frequency of failures over a time interval and it is a measure of success for a failure-free operation. Reliability is defined as the probability of continuous and correct operation during a time interval. For constant failure rates, it is often expressed as:

$$R(t) = e^{-\frac{t}{MTBF}} = e^{-\lambda \cdot t} \quad (1.3)$$

Where:

- t is the time at which the reliability is calculated;
- MTBF is mean time between failures; and
- λ is the failure rate (constant); $\lambda = 1/MTBF$.

This equation is used when the failure rate is assumed to be constant throughout the component's life; other expressions are required for other failure distributions [25].

1.4.2 Availability

Availability is the probability of having a system or component in correct operation in a specific moment. Availability $A(t)$ is expressed as the inverse of the unavailability $Q(t)$:

$$A(t) = 1 - Q(t) \quad (1.4)$$

Unavailability is expressed as:

$$Q(t) = \frac{\lambda}{\lambda + \frac{1}{MTTR}} \cdot \left[1 - e^{-(\lambda + \frac{1}{MTTR}) \cdot t} \right] \quad (1.5)$$

Where λ is the failure rate and MTTR the mean time to repair the system or component.

Mean availability is commonly expressed as (uptime)/(uptime + downtime) with many different variants. Uptime refers to capability to perform the task and downtime refers to inability to perform the task. The *inherent availability* is the availability during the scheduled operation time and is expressed as follows:

$$A_i = \frac{MTBF}{MTBF+MDT} \quad (1.6)$$

Where:

- MTBF is mean time between failures; and
- MDT is the mean downtime, i.e., operational mean time lost due to a failure.

Inherent availability reflects the fraction of time that a system would be available if no scheduled maintenance time is taken into account. This is an important parameter from the design point of view. Another way to express it is:

$$A_i = \frac{T_t - MDT_{Scheduled} - MDT_{non-Scheduled}}{T_t - MDT_{Scheduled}} \quad (1.7)$$

Where:

- T_t is the time in which the system is analyzed (e.g., one year, the whole lifetime);
- $MDT_{Scheduled}$ is the mean downtime due to scheduled maintenance; and
- $MDT_{non-Scheduled}$ is the mean downtime due to non-scheduled maintenance.

On the other hand, the *operational availability* includes planned maintenance periods. It is, therefore, the availability over the whole period of time:

$$A_o = \frac{T_t - MDT_{Scheduled} - MDT_{non-Scheduled}}{T_t} \quad (1.8)$$

For systems aimed at operating during specific periods of time, increasing inherent availability will be of primary importance. On the other hand, good operational availability performance will be essential for systems whose goal is to produce as much as possible throughout their whole lifetime.

1.4.3 Maintainability

A system should very rarely fail if a high availability is pursued; however, it should also be able to be quickly repaired. The repair activity must take into account all of the actions leading to system restoration, including logistics, manpower and tests among others. Maintainability is a measure of the aptitude of a system to be repaired.

Many designers seek top performance for their systems, without considering the possibility of failure; however, even when no effort has been spared to create a perfectly functioning system, it is of the utmost importance to consider what would happen in case of failure.

Thus, maintainability engineering must be a part of design planning. Maintainability characteristics need to be specified and incorporated during system design. The objective of maintainability is to develop equipment and systems that can be maintained in the least amount of time with the least cost and resources.

1.4.4 Inspectability

Tests and inspections can prevent long shutdowns or can waste valuable operative time. A balance must be achieved in regulations and good practices (e.g. passive systems like safety systems that need to be inspected periodically). Inspectability includes the accessibility of equipment and the removability of samples to evaluate the degradation and diagnostics in order to thereby determine incipient failure.

Inspectability concerns also the monitoring aspect during the various stages of production as well as the testing period for the inspection processes. Inspectability allows to easily finding causes of failures or possible consequences in other systems and components.

1.5 RAMI analyses for IFMIF

IFMIF high availability is a fundamental requirement for the international fusion roadmap. It is essential to obtain the fusion materials database in order to find suitable materials for DEMO design within the anticipated timeline. RAMI analyses are being performed from the early stages of the IFMIF design to meet such requirements.

During the engineering design phase, RAMI analyses were performed by the RAMI team, composed of one RAMI officer for each facility (Accelerator, Test, Target and Conventional Facilities) and a RAMI coordinator. Moreover, contributions were made throughout by institutions, experts and designers. The results of the analyses helped the design of each facility evolve to achieve better RAMI performances.

1.5.1 Previous analyses

RAMI analyses have been done in every IFMIF design stage. Previous RAMI analyses are gathered in the following documents:

- CDA (1996) [18], KEP (2003) [22] and CDR (2004) [15]
- Adjoint sensitivity analyses procedure of Markov Chains with application on reliability of IFMIF Accelerator-System Facilities (2004) [26]
- Developing the IFMIF RAM planning (2009) [27]
- RAMI Guidelines (2009) [28]
- Data management and data capture methodology from IFMIF prototypes (2010) [29]
- Exploration of reliability databases and comparison of former IFMIF's results (2010) [30]
- IFMIF accelerator: Database, FMEA, Fault Tree and RAM (2010) [31]

All these documents served as a basis to develop the analyses performed in this thesis. Guidelines, databases, experiences in other facilities and first availability analyses of the accelerator were used to perform the RAMI analyses of the accelerator facility during the Engineering Design Phase.

1.5.2 IFMIF RAMI Requirements

The operational availability requirement for IFMIF was established at 70% [18]. This availability requirement was linked to the fusion program and to the goal of producing a neutron source that allows accelerated materials testing. It is equally important to have high neutron intensity than to have good availability performances; both parameters affect to the capability of performing tests in acceptable periods of time. Therefore, high neutron intensity is pursued as well as an excellent operational availability. This operational availability implies to have short maintenance periods and to have a design capable of withstand large operational periods without failures. Moreover, actions to be performed in non-scheduled maintenance periods should allow continuing operation in short periods of time.

The current maintenance plan is composed of two scheduled periods per year [32]:

- One long maintenance period of 20 days for general maintenance: mainly for maintenance in the lithium target facility, replacement of test modules, and long-term accelerator maintenance.
- One intermediate maintenance period of 3 days for short-term maintenance activities in the accelerator and other auxiliary and conventional systems.

Inherent availability requirements were distributed among facilities taking into account the maintenance plan and the operational availability requirement. As a result, the inherent availability requirement is 75% for the whole IFMIF. This hardware availability budget was shared between the facilities [32] to obtain the inherent availability requirements in each:

IFMIF Facilities	Availability requirements
Test Facility	96%
Target Facility	94%
Accelerator Facility	87%
Conventional Facilities	98%
Central Control System & Common Instr.	98%
TOTAL (product)	75%

Table 1.2 – IFMIF inherent availability goals

The inherent availability requirement for the IFMIF accelerator facility is 87%. This value was established as the mean availability goal for the accelerator facility RAMI analyses.

IFMIF requirements are given in terms of availability. No specific reliability requirements have been established, only the reliability requirements derived from availability requirements; however, a limited number of shutdowns or other restrictions involving reliability could be considered. To estimate this parameter, rough beam trip estimation was done (described in subchapter 9.3).

Chapter 2

Purpose of the thesis

The present work summarizes the RAMI activities performed for the IFMIF accelerator facility during the engineering design phase. This thesis has four main goals:

- *Define and execute a methodology to include the RAMI analyses in the IFMIF accelerator design.*
- *Choose, develop and adapt adequate tools to conduct the analysis of the accelerator.*
- *Carry out the RAMI studies to analyze the design in the different design phases.*
- *Find weak points of the design, propose improvements, and give recommendations to enhance the availability performance in an effort to achieve the availability requirements.*

As this has been an iterative process conducted over more than three and a half years, there is no easy way to describe precisely the evolution of the design and the detailed progress of each system and its RAMI analyses. As requirements, tools, designs and assumptions have been modified in this process, the information shown in this thesis is mainly related to the last iteration; however, some description of the evolution and results of previous analyses is included in the document.

Chapter 3

State of the art

To contextualize the analysis done in this thesis within the current state of the art, it is important to compare the IFMIF accelerators with other current high-power accelerators and to see how RAMI analyses are done in similar facilities.

3.1 IFMIF accelerators

High-power proton accelerators have progressed and evolved over the past four decades. An increase in both peak intensity and average flux has made it possible for applications such as spallation neutron sources, production of tritium, nuclear transmutation and Accelerator-driven systems (subcritical nuclear fission reactor) among others [33]. For some of these applications, however, the technology is not yet mature and development in this field is still advancing.

IFMIF accelerators will be one of the most powerful machines of its kind ever built. The feasibility of IFMIF beam performance requirements was historically doubted due to its high technological challenges; however, these doubts vanished in 2000 with the successful commissioning and operation of LEDA in Los Alamos [34,35]. Protons were accelerated up to 6.7 MeV at 100 mA with a 99.7% duty cycle for long periods of time.

Notwithstanding, the decision to build a prototype of the IFMIF accelerator (LIPAc) in order to validate the performance was necessary due to its higher current and energy than those of LEDA. Moreover, there are differences in RFQ frequency (350 MHz for LEDA and 175 MHz for IFMIF), and there is an additional accelerating stage for IFMIF. In addition, the use of deuterons will be useful for nuclear safety considerations.

Existing, under-construction and proposed accelerators are displayed in Figure 3.1 according to beam energy and beam current. IFMIF’s beam energy is not as high as that of other accelerators; however, its beam current is more than one order of magnitude higher than nearly any other accelerator. This has lead IFMIF to be the most powerful accelerator; the technology required to achieve the specifications is on the cutting edge.

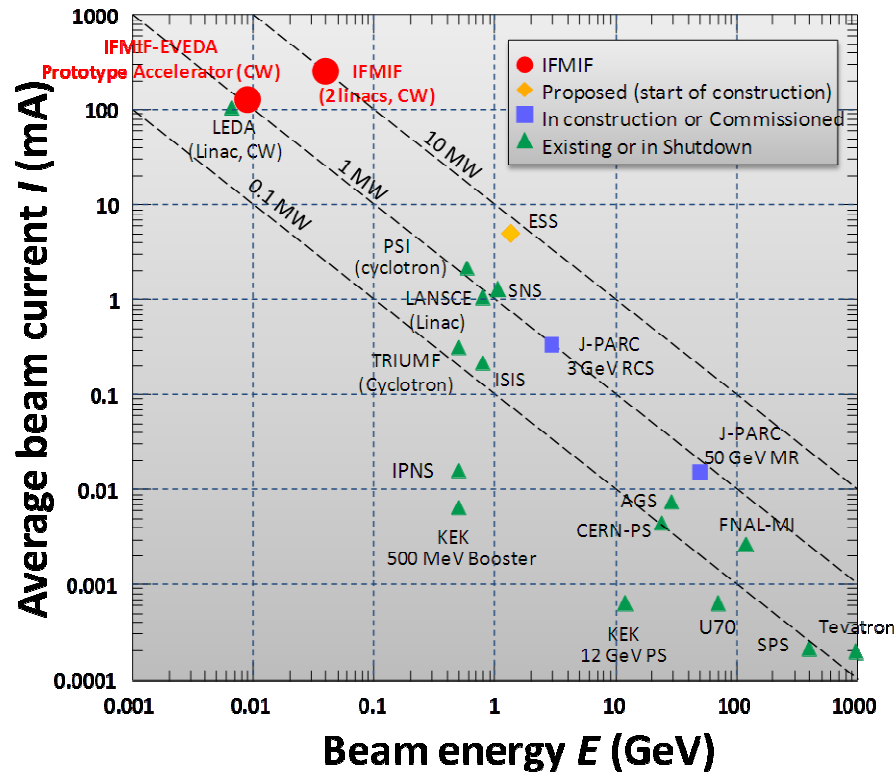

Figure 3.1 – Particle accelerators considering average beam current, energy and power [36]

Due to the novelty of the IFMIF accelerator technology, the design has encountered many challenges. As a result, the design has undergone several changes, modifications and reevaluations. The design and evolution during the engineering design phase are explained in Chapter 4.

As these are unparalleled machines and designs, no operational data is available and there are no other machines to use as comparisons. This is why many assumptions and hypotheses have to be made about operation performance, reliability data and consequences of failure during the RAMI process.

3.2 RAMI analyses in particle accelerators

The first reliability models emerged during World War II to assist in the creation of more reliable radar and rockets [37]. Until the 1970s, these analyses were not applied to accelerators because the users were generally the designers, whose goal was to achieve high intensities and energies even while accepting the possibility of long and repeated failures [37]. In that decade, some accelerators were constructed as user facilities; therefore, a primary concern arose in regard to availability and reliability. Meson factories, synchrotron radiation sources and medical treatment machines started having user requirements as well as production and economical concerns.

Dependability analyses are very common in industry; tools, methodologies and procedures have been developed for many decades; however, few accelerator facilities have considered RAMI or dependability analyses during their design phases. Usually, only basic considerations related to designers' common sense, past experience and good practices were taken into account. Generally, when facilities achieve their beam parameter goals, they start improving their reliability and maintainability performances and turn their attention toward maintainability and logistics issues. Design improvements and maintenance policies are proposed to improve their performance once the machine has been operating and has shown its weaknesses.

It is noteworthy that many facilities have considered reliability in safety analyses and in machine protection systems in order to avoid huge machine damage and large shutdown periods like in LHC [38,39]. Some of the tools used in these analyses can be similar to those used in RAMI, but the goals and results of the studies can be different.

Dependability analyses can have different goals depending on the facility or machine being analyzed. For example, for an aircraft, the main goal is to be reliable: to have the minimum probability of failure. On the other hand, for assembly line production, the goal will be availability, i.e., to produce as much as possible. Particle accelerators can also have different goals and requirements. For an ADS facility, the principal goal will be to have the minimum number of stops per year (with a specific duration). In the transmutation and production of tritium accelerators, their principal goal will be to remain operative for as much time as possible throughout their lifetime. On the other hand, for user's facilities such as synchrotrons, the goal is to be as reliable and available as possible during the scheduled period of time when the user is using the machine. These facilities often have large maintenance periods, and are operative only certain hours of each day or certain days of each week. Therefore, analysis, design, maintenance and operation policies will depend on the type of accelerator performance being pursued.

Performing RAMI analyses from the early design phase can have a huge impact on the final performance of an accelerator; however, the analyses done in a non-detailed and

non-frozen design process produces a lot of uncertainty and generates a lot of difficulties for the analyses.

When comparing dependability analyses done in different facilities, it is important to take into account the goals of the analyses (e.g., availability, reliability), the phase in which the analyses are done (e.g., design, operation), and the data which is available for that kind of machine (e.g., unique or one of several similar operative machines). Moreover, these analyses can be done in different depths; e.g., just rough indicative values or specific and detailed contributions of each component and/or failure mode.

IFMIF accelerator RAMI analyses focus mainly on availability and are done during the design phase. Also, there are few facilities to compare with. Moreover, these RAMI analyses are done with enough detail to propose specific design improvements to achieve the requirements. These characteristics make the analyses done in this thesis very unique.

Some of the accelerator facilities that consider or have considered availability and reliability in their design phase are LANSCE [40–42], SNS [43], XFEL [44], APT [45], ELETTRA [46], LHC [47,48], SLC [49], RIA [50] among many others. However, only facilities with special reliability or availability concerns develop an extensive and profound analysis from the very beginning of the design phase. At this moment, there are two projects that have been pushing the state of the art over the last years. Thus, they have been used in this thesis as points of reference:

3.2.1 International Linear Collider (ILC)

This facility will have over 20 km of superconducting linear accelerator and two 6-km-circumference damping rings, as one of the most complex machines ever built. This machine will have an order of magnitude more components than most accelerators [51]. This means that the accelerator will also have an order of magnitude more failures, which implies that the machine will be barely operative [52].

An important effort was made to gather and classify operations of existing facilities in a clear and useful way. Moreover, specific reliability and availability definitions for accelerator facilities were done [53].

Spreadsheets and commercial tools were not enough to calculate and simulate the whole performance of the ILC and its complexities. That is why the ILC reliability team developed a software program capable of simulating the accelerator's performance [54]. This software has been adapted, modified and used for IFMIF (Chapter 11).

ILC used these tools and knowledge obtained from past experience to develop a design with good reliability and availability performances in a cost-effective way. A flexible

machine capable of withstanding failures was pursued. Moreover, components and systems that needed to improve their current reliability values were identified [54].

3.2.2 Accelerator-Driven Systems (ADS)

ADS may be employed to address several missions, such as nuclear waste transmutation, fissile materials production and the generation of electricity in subcritical reactors [55]. One of the top requirements is that the annual number of beam trips in the accelerator has to be very low in order to avoid thermal stress and fatigue on the reactor structures, the target, and the fuel elements. Moreover, a good availability performance is necessary to achieve an industrial scale production or to have economically profitable power generation plants. The ADS requirements for different missions are as follows:

	Transmutation Demonstration	Industrial-scale Transmutation	Industrial-scale Power Generation with Energy Storage	Industrial-scale Power Generation without Energy Storage
Beam power	1-2 MW	10-75 MW	10-75 MW	10-75 MW
Beam energy	0.5-3 GeV	1-2 GeV	1-2 GeV	1-2 GeV
Beam time structure	CW/Pulsed	CW	CW	CW
Beam trips (t < 1s)	-	<25000/year	<25000/year	<25000/year
Beam trips (1 < t < 10s)	<2500/year	<2500/year	<2500/year	<2500/year
Beam trips (10s < t < 5min)	<2500/year	<2500/year	<2500/year	<250/year
Beam trips (t > 5min)	<50/year	<50/year	<50/year	<3/year
Availability	>50%	>70%	>80%	>85%

Table 3.1 – Range of parameters for accelerator-driven systems for four different missions [55]

As will be seen in the beam trips analysis in Chapter 9, these requirements are far from the trip rates of current accelerators.

To overcome these dependability challenges, studies [56] and design proposals [57] have been done to improve the reliability for future designs. Studies about fault-tolerant designs with fast tuning and recovery procedures have been done, together with gathering best practices from other facilities, to decrease the number of beam trips as much as possible [58–61].

Chapter 4

IFMIF accelerator design

The accelerator facility is composed of two independent accelerators, each producing a 40 MeV, 125 mA deuteron beam. Both beams are focused toward a common target formed of a lithium jet. Each IFMIF accelerator is comprised of a sequence of accelerating and beam transport sections. The basic configuration of one accelerator line is described in this chapter. It must be noted that the configuration of the two accelerators is the same.

The deuteron beam is produced and extracted at the Injector, which is an Electron Cyclotron Resonance (ECR) ion source, at 100 keV. A Low-Energy Beam Transport (LEBT) section guides the deuteron beam from the source to a Radio Frequency Quadrupole (RFQ). The RFQ then bunches the beam and accelerates it up to 5 MeV. Its output beam is extracted through a matching section called the Medium-Energy Beam Transport (MEBT) line, which guides the beam up to the next accelerating and focusing system: the Superconducting Radio Frequency (SRF) linac, which is composed of four cryomodes. In this section, 42 superconducting cavities and 21 solenoids bring the beam energy up to 40 MeV. Finally, a High-Energy Beam Transport (HEBT) line guides and shapes the beam to produce a rectangular and uniform footprint at the entrance of the lithium target [62]. In addition, other systems such as the Radio Frequency power system, beam diagnostics or auxiliary systems are required for the proper operation of the accelerator.

The information in this chapter comes mainly from the Detailed Design Documents of each system of the accelerator [63–71] and from the IIEDR plant design description document [13].

4.1 Accelerator facility main requirements

The main design requirements for the accelerator facility are:

Requirement	Target value	Comment
Particle type	D ⁺	H ⁺ for testing
Accelerator type	RF linac	At 175 MHz
Number of accelerators	2	Parallel operation
Output current	250 mA	125 mA per accelerator
Beam distribution	Rectangular flat top	20 cm horizontal × 5 cm vertical
Output energy	40 MeV	User requirement
Output energy dispersion	± 0.5 MeV FWHM	Target requirement
Duty factor	CW	Pulsed tune-up and start-up
Availability	≥ 87 %	During scheduled operation
Maintainability	Hands-on	HEBT with local shielding is required
Design lifetime	30 years	
Short pulses	≤ 1 ms pulse width	10 Hz Maximum pulse repetition frequency
Long pulses	> 1 ms	1 Hz / Maximum duty cycle 50%
Total heat load	19.2 MW	Water primary cooling loops for whole AF
Total electric power	53 MVA	Whole AF

Table 4.1 – IFMIF Accelerators parameters and design requirements

4.2 Beam dynamics implication in the design

The IFMIF beam intensity, 125 mA CW, is the highest intensity ever targeted at this energy level. As a result, the highest beam power as well as the highest space charge will be achieved. These characteristics imply severe beam dynamics constraints, which are considered in the design.

The strong space charge induced by the high intensity poses design and operation challenges to limit beam halo and emittance growth. High compactness is needed to achieve these requirements; consequently, space for instrumentation is limited and design flexibility is narrow.

For the low-energy part ($E < 5$ MeV), the main concern is to reduce beam losses to reach the desired current of 125 mA; beam losses are some percentage of the beam (from 140mA to 125mA). On the other hand, for the high-energy part ($E > 5$ MeV), material activations become significant. As the accelerator must be designed for hands-on maintenance, in this second part, the losses must be limited to less than 10^{-6} of the beam intensity.

With such beam power, any deflection on the beam that would provoke a collision with the beam pipe would imply enormous damages to the machine. A fast and reliable machine protection system involves a significant amount of forethought.

4.3 Plant distribution

In Figure 4.1, the distribution of all IFMIF facilities is shown. The accelerators will be mainly placed on the first floor (Figure 4.2) with RF sources and high-voltage power supplies on the second floor (Figure 4.3). In these figures, the accelerator rooms are coloured blue.

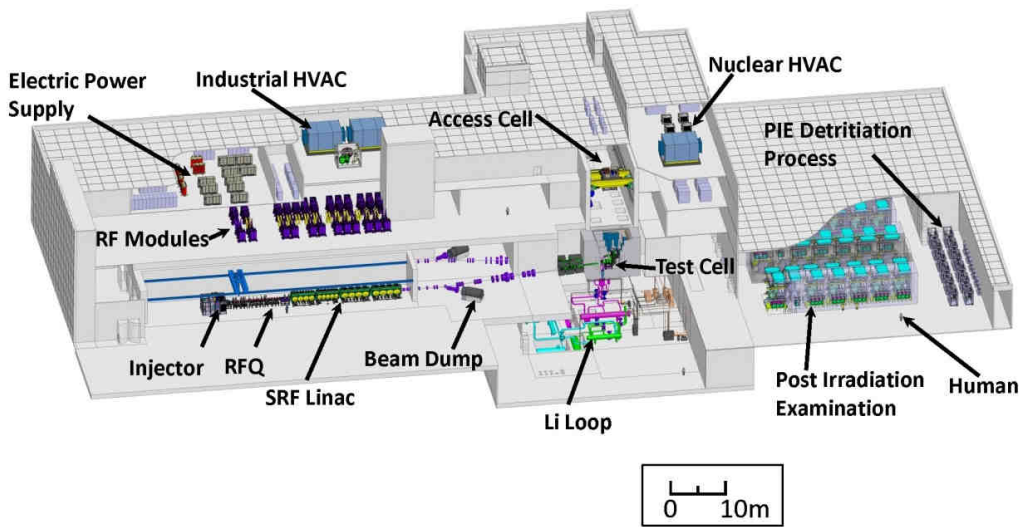

Figure 4.1 – IFMIF building: Accelerator, Test, Target and PIE facilities

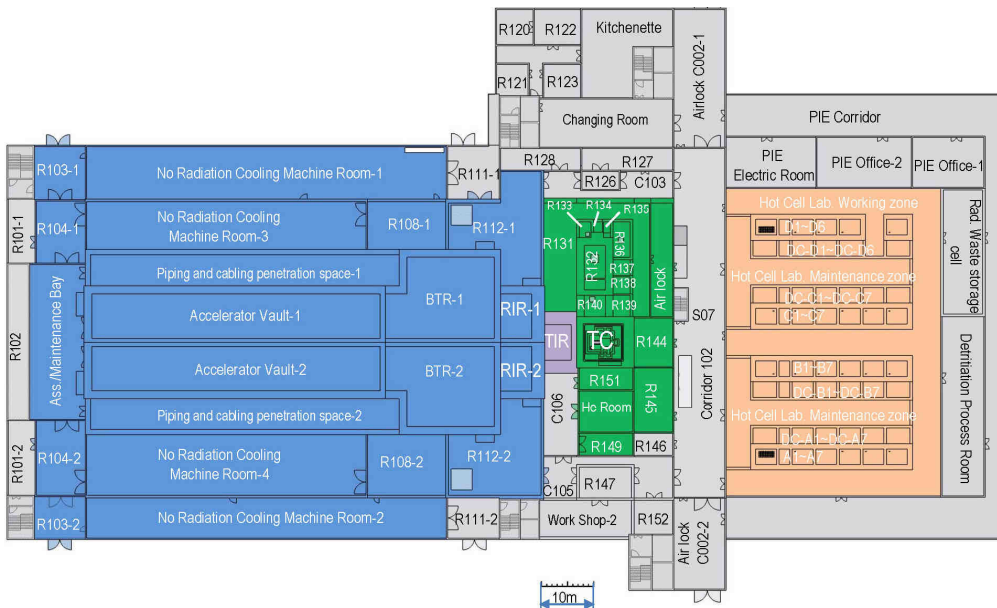

Figure 4.2 – First floor of the IFMIF

The accelerators are placed inside the two vaults and connected to the target and test facilities through the BTR, RIR and TIR rooms where the HEBT shapes the beam. In these rooms, a physical separation is achieved between the accelerator vault and the test cell. All auxiliary systems and maintenance tools are in the rooms around the accelerator vault. On the second floor, RF power sources are connected through waveguides to the accelerator.

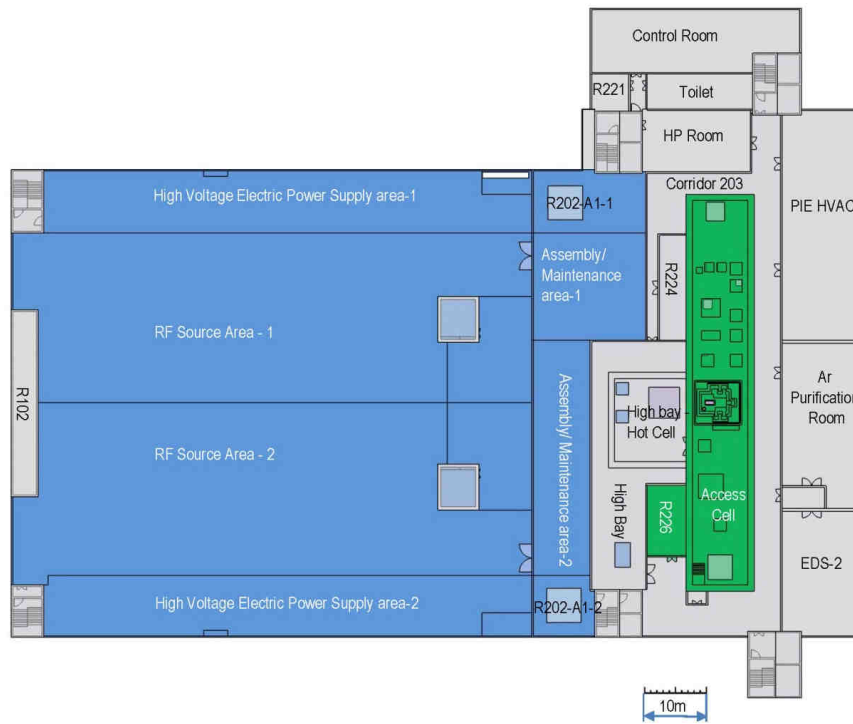

Figure 4.3 – Second floor of the IFMIF

4.4 Accelerator design description for each system

The main systems and sections of the accelerator are described in this subchapter. The main parts are the ECR ion source, LEBT, RFQ, MEBT, SRF linac, HEBT, beam dump, RF power, diagnostics and ancillaries.

4.4.1 Injector

The Injector has to deliver sufficient current to the first accelerating cavity (RFQ) to achieve a 125 mA RFQ output current. Due to expected beam losses in the RFQ, this current value requires the ion source to produce a 140 mA maximum deuteron beam with excellent beam quality (low transverse emittance).

The IFMIF injector consists of the ECR ion source and the LEBT section. Different kinds of ion source were studied, but the one selected was an Electron Cyclotron Resonance (ECR) source at a frequency of 2.45 GHz at 875 Gauss. It will deliver a deuteron beam of 140 mA at 100 keV in CW.

The ECR source generates high-density plasma by RF power, which is confined magnetically. The deuterium injected into an ECR source is the only material consumed (in contrast to the antenna sources). As a result, ECR sources can be operating quasi-continuously for long periods of time without interruption. Maintenance required on ECR sources is also minimal. Different extraction configurations have been studied, while varying the electrode aperture diameter as well as the number, geometry and voltage of the electrodes. A five-electrode configuration was finally chosen and positively tested during the EVEDA phase.

The Low-Energy Beam Transport (LEBT) is essentially a weak pair of focusing magnets (solenoids) that have to match the beam to the RFQ input needs. This is necessary to provide optimal acceleration and to avoid activation of the RFQ. There are also a couple of steerers used to focus the beam in the transverse direction if it deviates. To minimize emittance growth, the length of the IFMIF LEBT has been reduced as much as possible.

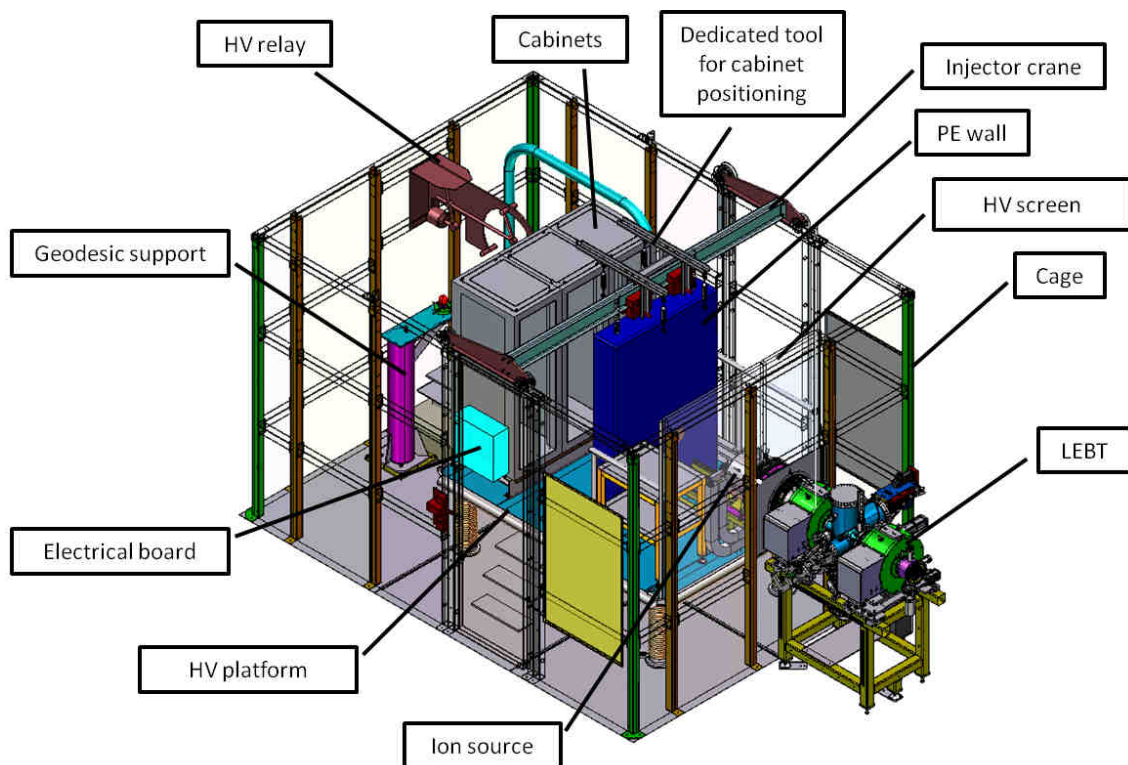

Figure 4.4 – Ion source and LEBT with HV cage

A fast chopper has also been included in the LEBT to allow higher operational flexibility to the accelerator both during the commissioning phase as well as during normal operation.

Principal Injector and LEBT requirements are summarized in Table 4.2.

Requirement	Target value	Comment
Injector & LEBT output energy	0.95 MeV	Fixed by the RFQ acceptance
Injector output D+ current	140 mA	Assumes an RFQ transmission $\geq 90\%$
Injection normalized rms transverse emittance	0.25π mm mrad	At the output of the LEBT

Table 4.2 – Injector and LEBT requirements

4.4.2 RFQ

Radio Frequency Quadrupoles (RFQs) are used in the first acceleration stage where space charge forces have a higher effect because of the low-energy beam. Its aim is to accelerate the beam to an energy level high enough that the effect of the space charge is lower; this allows the beam to be handled more efficiently by the acceleration system. In addition, the RFQ must provide continuous transverse focusing and must bunch the beam.

Due to the high space charge, the particles have to be accelerated to an energy of 5 MeV before the next acceleration stage, making IFMIF the longest RFQ ever constructed; however, higher beam energy results in a higher beam power as well as higher loss power, which can become a concern. Besides, any beam loss at high energy will induce higher activation of the RFQ.

The RFQ is segmented into three longitudinal RF supermodules. Each of the three RF supermodules is made from six smaller physical segments that are each approximately 0.5 m long. The RFQ structure will be ~ 10 m long.

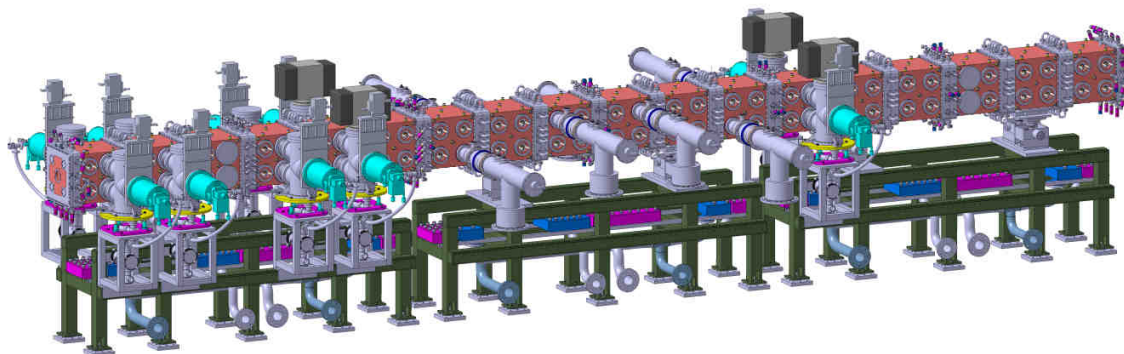

Figure 4.5 – RFQ drawing with RF couplers and pumping system

The acceleration of the beam is achieved by means of RF fields in the four-vane resonator. The frequency of the RFQ is tuned after installation by means of slug tuners, and adjusted precisely in operation through the temperature of the cooling water. The vacuum conditions inside the RFQ, related to the gas load (mainly determined by beam losses), are sustained by a vacuum system based on cryogenics pumps. RF power delivery to the RFQ is provided through eight RF couplers by the power coaxial lines.

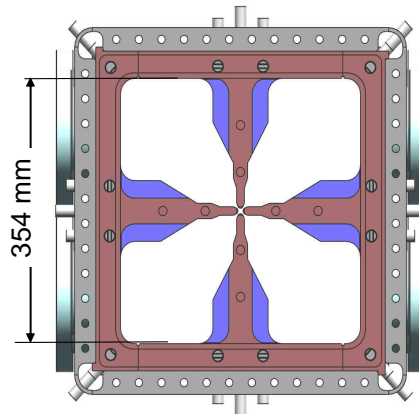

Figure 4.6 – RFQ four-vane module

The RFQ cavity is a robust structure that is expected to require little routine maintenance. The RFQ will require replacement of the first segment of the cavity due to excessive erosion of the vane tips from beam scrape-off. Maintenance and operation plans demand that this operation will be performed in the accelerator vault, during a scheduled maintenance period, with a minimum of accelerator disassembly.

Main requirements for the RFQ are shown in Table 4.3.

Requirement	Target value	Comment
Input energy	100 keV	$\pm 100\text{eV}$
Output energy	5 MeV	$\pm 50\text{ keV}$
Output current	125 mA	Nearly all losses below 2 MeV
Beam losses	< 5 mA	<0.1 mA between 4 MeV and 5 MeV
Input normalized emittance (rms)	$0.25 \pi \text{ mm mrad}$	
Tuning range with water temperature	+ 100 kHz	Measured in high-power tests on last modules
RF power dissipated in the RFQ chopper	585 kW	At nominal field level
Max heat transmitted at heat exchanger	1000 kW	
Max surface field	< 25.2 MV/m	1.8 Kilpatrick field (design criteria)
Output rms emittance (norm.) transv.	< $0.30 \pi \text{ mm mrad}$	At the RFQ output
Output rms emittance longitudinal	<0.2 MeV deg	
Vacuum tightness	10^{-10} hPa/l/s	For each module

Table 4.3 – RFQ requirements

4.4.3 MEBT

The main functions to be performed by the MEBT are to transport the beam (from the RFQ to the SRF linac), to bunch it (i.e., to keep the RFQ output beam quality in accordance to the SRF linac input requirement, in order to have sufficient tuning capabilities to match the real RFQ output beam to the SRF linac input specifications), and to collimate it (scrapers have to be implemented in the MEBT to stop the out-of-emittance beam particles before injection into the SRF linac).

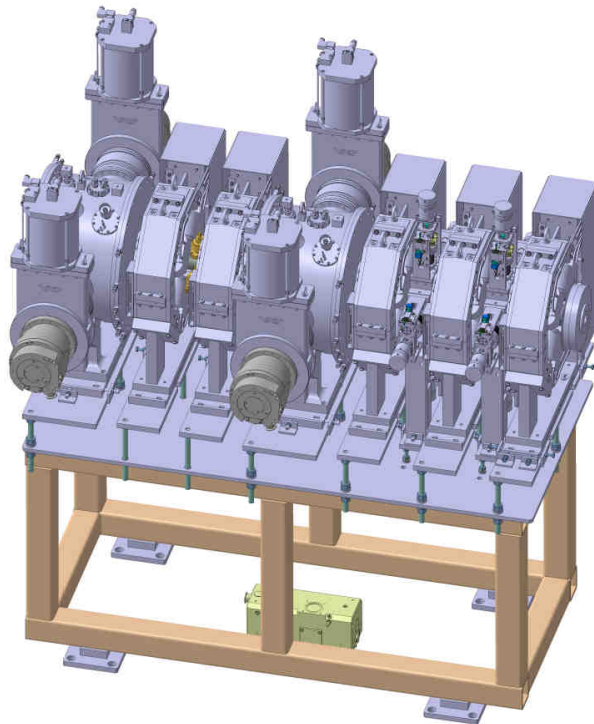

Figure 4.7 – 3-D view of the MEBT

The MEBT will be made of two rebuncher resonant cavities (with power couplers to supply the RF from the chain to the resonator), a tuning system and five quadrupoles (one doublet and one triplet) that will provide the required transverse and longitudinal focusing for the transport and matching of the RFQ output beam and the entrance of the SRF linac. Four of the five quadrupoles will contain two pairs of steerers (one vertical and one horizontal).

Between the buncher cavities, several beam pipe sections will ensure the proper vacuum on the beam line and the installation of the interfaces with the RFQ, SRF linac and other necessary elements: diagnostics (four BPMs and one CT), two pairs of scrapers to improve the beam quality, and the rest of the vacuum chambers.

Principal design requirements are described in Table 4.4.

Requirement	Target value
Rebuncher EOLT	350 kV
Quadrupole magnetic field gradient	25 T/m
Steerer strength (horizontal and vertical)	25 G·m
β value	0.073
Input energy / Output energy	1
Beam aperture diameter	44 mm
Unloaded quality factor	104

Table 4.4 – MEBT requirements

4.4.4 SRF linac

The objective of the SRF linacs are to transport and accelerate the deuteron beam of 125 mA nominal intensity from 5 MeV (MEBT exit) to 40 MeV (HEBT entrance) in CW. A reference configuration of SRF linacs proposes a 22.7 m long linac, consisting of four cryomodules of three different types (Table 4.5).

Cryomodules Content			
Cryomodules	#1	#2	#3 & #4
Nb cavities / cryomodule	1 × 8	2 × 5	3 × 4
Nb solenoids / cryomodule	1 × 8	1 × 5	1 × 4
Cryostat length (m)	5.44	5.30	(TBD)
Output energy (MeV)	9	14.5	26 / 40

Table 4.5 – Cryomodules contents

The acceleration of the beam is accomplished by means of RF fields produced in superconducting Half-Wave Resonators (HWRs). The frequency of the HWR is adjusted precisely by using a mechanical tuner. The cryostat has the function of maintaining the temperature of the superconducting elements at 4.4 K, keeping the internal components under a vacuum and insulating them from the external 300 K ambient temperature and atmospheric pressure. Furthermore, it shields the HWR components from the earth's magnetic field. For the beam focusing, 21 superconducting solenoids are distributed among the cryomodules. The baseline design is the result of a conservative approach for both the resonators and the focusing lattice.

RF couplers have to provide 200 kW maximum to the HWRs. For this high-power application, ceramic windows at room temperature were chosen. The windows are far from the superconducting cavity, so that the RF dissipation does not affect the cryogenic heat load.

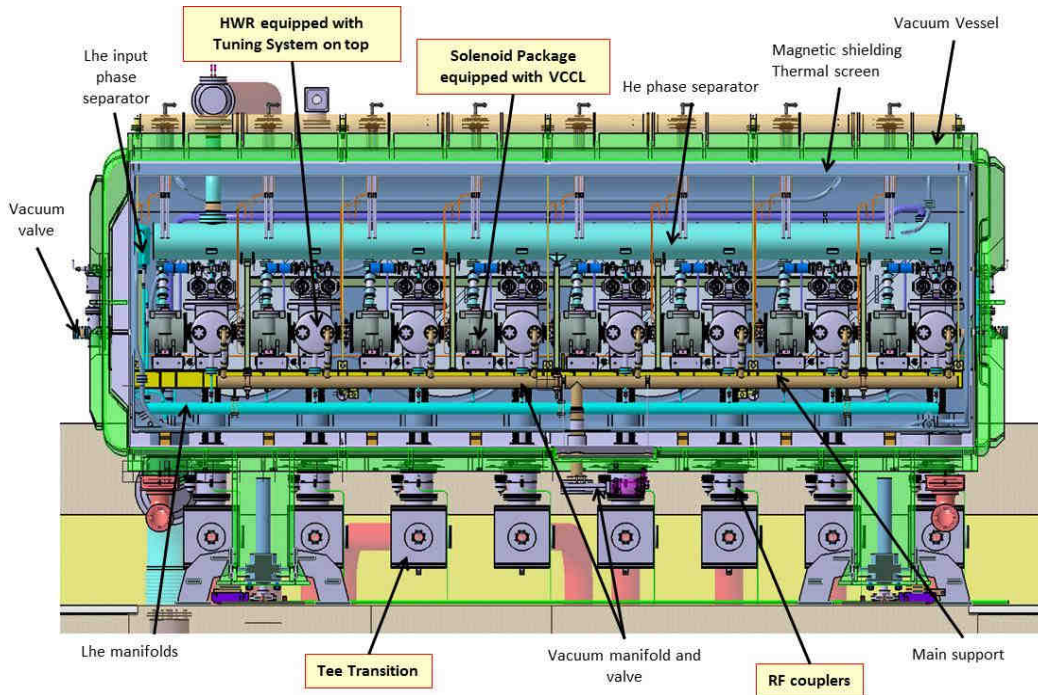

Figure 4.8 – Components inside the first SRF linac cryomodule

As it is a superconducting linac, a cryogenic plant will be required to supply the liquid helium to the cryomodules. This plant is part of the accelerator’s ancillary systems.

Main SRF linac requirements are shown in Table 4.6.

Requirement	Target value	Comment
Cavity type	Half-Wave Resonators	Superconducting (LHe-cooled)
Input energy / Output energy	5 / 40 MeV	4 cryomodules (42 cavities)
Accelerating field (Cavity low-β type)	5.0 MV/m	β value = 0.094
Quality factor (Cavity low-β type)	1.4×10^9	β value = 0.094
Accelerating field (Cavity high-β type)	TBD	β value = 0.166
Quality factor (Cavity high-β type)	TBD	β value = 0.166
Solenoids’ magnetic field B_z on axis	6.0 T	
Solenoids’ residual field at cav. flange	20 mT	
Beam aperture	40 mm/48 mm	For low/high β

Table 4.6 – SRF linac requirements

4.4.5 HEBT

The High-Energy Beam Transport (HEBT) has the purpose of transporting the beam from the exit of the SRF linac to the target. The main functions fulfilled by the HEBT are to

guide the beam by means of magnetic elements up to the lithium target and to deliver a beam footprint according to the IFMIF operation requirements. The main design requirements are to tune and online monitor all the strategic beam parameters (e.g., intensity, position, profile) and concentrate the unavoidable beam losses at specific locations, where dedicated scrapers are located to minimize the activation of the HEBT components so that limited hands-on maintenance operations remain possible. Moreover, it must ensure the right level and quality of the vacuum, especially at the SRF linac exit and provide the means for surely and rapidly isolating the accelerators from the lithium target upon emergency request. In addition, it must guide the beam to the Beam Dump when needed (delivering the right footprint at its entrance).

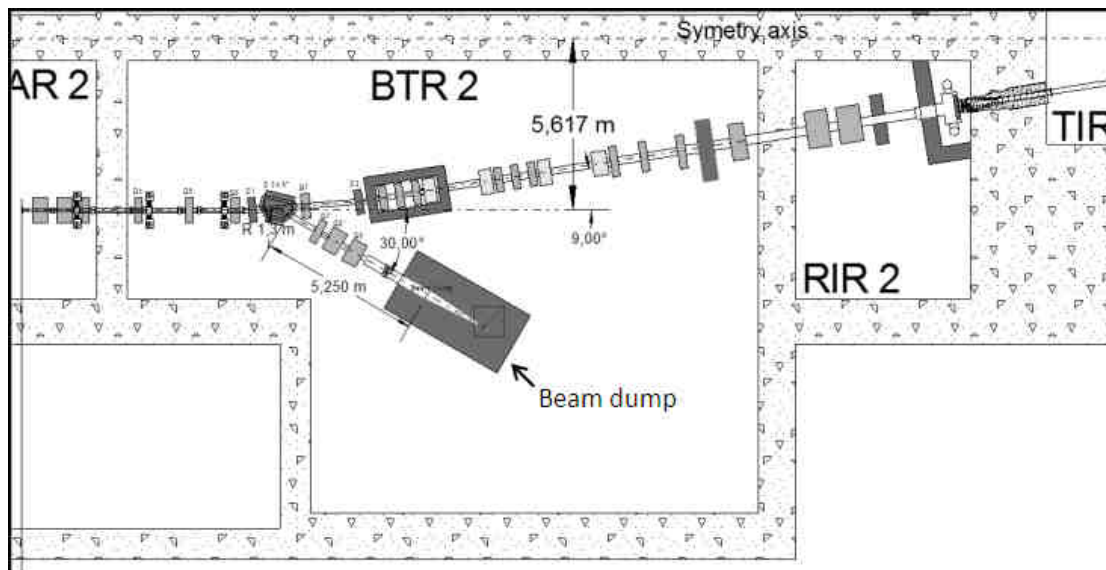

Figure 4.9 – HEFT line, the magnet elements and the beam dump

The IFMIF’s HEFT line (Figure 4.9) is a long transport line (45 m from the exit of the last cryomodule up to the lithium surface) where an achromatic 9° bending system located 9 meters downstream of the SRF linac steers the beam toward the lithium target. The guiding and the shaping of the beam are ensured by 18 quadrupoles, 2 dipoles, 2 dodecapoles and 2 octupoles. In addition, a set of steering magnets shall be arranged all along the line for aligning the beam with the line axis. The main HEFT requirements are:

Requirement	Target value	Comment
SRF/HEFT beam emittance	0.3πmm.mrd (RMS norm.)	At the exit of the SRF linac
Nominal transmission ratio	>99.8%	~ 10 ⁻³ of the beam stopped on the collimators
Pressure at SRF linac interface	< 5.10 ⁻⁶ Pa	SRF linac valve closed
Pressure at the LT interface	< 10 ⁻⁴ Pa	RIR/TIR valve closed

Table 4.7 – RF power chains required by each accelerator section

4.4.6 Beam dump

The beam is addressed to the beam dump when the target or the test facilities are not ready for the beam or when the accelerator is under commissioning or in the beam turn-on process. The beam dump and its configuration can be seen together with the HEBT line in Figure 4.9.

4.4.7 Diagnostics

Beam measurements play a critical role in the IFMIF accelerators due to their uncommonly high beam current and beam power. Beam instrumentation must guarantee the successful operation of the accelerator from commissioning phases to the full power operation. Hence, the main objective is to provide all necessary information to properly transport and accelerate the beam from the source to the lithium target, and to fully understand and measure all beam characteristics.

Beam diagnostics and instrumentation are present throughout the whole Accelerator Facility. There are diagnostics inside the MEFT (e.g., beam current, beam position and phase), the SRFs (e.g., beam position and phase, micro losses, beam loss) and HEBT (e.g., beam position and phase, beam transverse profile, beam current, bunch length, emittance measurements, energy spread, beam losses, mean energy, beam halo).

4.4.8 RF power system

The main function of the Radiofrequency Power System (RFPS) is to provide the required RF power to each IFMIF Accelerator; accordingly, the RFPS is defined as the equipment necessary to convert the high-voltage AC primary power to suitably conditioned RF power for input to the IFMIF accelerator cavities. All of the relevant electronics, packaging, and internal cooling are included, ranging from the frequency source and the high-power RF transport to the cavities.

A very important goal of RFPS design is the strong availability and maintainability requirements of the IFMIF accelerator. Due to the high number of components in the system as a whole, the fault probability is not negligible, even if each element has a high level of reliability. When a fault occurs in a conventional RF amplifier system, the accelerator must be stopped, the problem fixed, and the defective element removed. All of this can take a significant amount of time; moreover, it is sometimes necessary to remove equipment that has not failed but impedes access to the failed device. The design of this system aims to overcome these difficulties and to fulfil the IFMIF specifications in terms of availability and maintainability. To this end, a system based on removable and interchangeable modular assemblies has been designed. Each RF module contains two

complete RF power chains, and is composed of two removable wheeled platforms; one for the circulators and another for the RF amplifiers and the auxiliary components (see Figure 4.10).

This configuration allows easy maintenance and fast replacement of modules (using fast connectors for electrical feeding, cooling, control and RF transmission lines), which in turn leads to better maintainability. This also makes it possible to keep all coaxial lines in parallel from the circulator output to inside the vault. Once inside the vault, coaxial lines meet RF couplers by u-shapes with different angles.

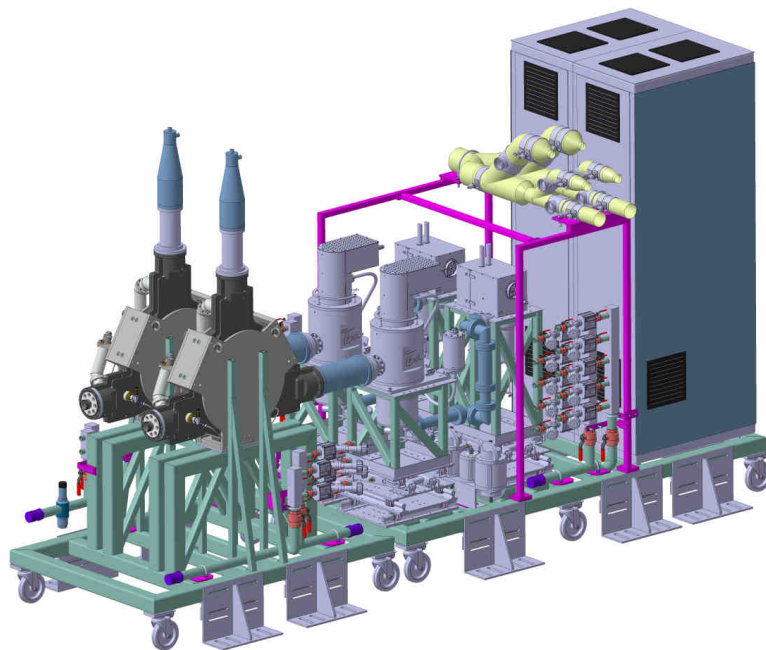

Figure 4.10 – One removable RF module with two RF power lines

The IFMIF RFPS modules contain all the necessary equipment to generate the required conditioned RF power to feed the IFMIF cavities. The cavities of one IFMIF Accelerator require 52 RF power inputs at 175 MHz (each fed by one RF amplifying chain). Each tetrode-based chain consists of a Low-Level RF, a pre-driver amplifier (a 400 W solid-state amplifier), a driver amplifier (TH561 Tetrodes) and a final power amplifier (TH781 Tetrodes). Each module is composed of two chains, the power supplies, the control and protection systems, and the common auxiliaries

There are three different modules that supply power up to 200 kW, 105 kW and 16 kW (solid-state power amplifiers), respectively. The quantities of RF power lines required for each accelerator system are shown in Table 4.8.

Power amplifiers	16 kW	105 kW	200 kW
RFQ cavity	-	-	8
MEBT cavities	2	-	-
Cryomodule 1	-	8	-
Cryomodule 2	-	10	-
Cryomodule 3	-	-	12
Cryomodule 4	-	-	12
Total for 1 accelerator	2	18	32
Total for 2 accelerators	4	36	64

Table 4.8 – RF power chains required by each accelerator section

The principal design requirements to be fulfilled by the RFPS can be seen in Table 4.9.

Requirement	Target value	Comment
Phase stability	$\pm 1^\circ$	Closed loop
Amplitude stability	$\pm 1\%$	Closed loop
Bandwidth	± 250 kHz	-1dB bandwidth

Table 4.9 – RFPS requirements

4.4.9 Accelerator ancillary systems

The objective of the Accelerator Facility Ancillaries is to provide all utilities, equipment and means for covering all of the needs of the Facility, throughout its life cycle (e.g., preparation and tests of components, installation, tuning, operation, maintenance, repair). The functions of the systems consist of adapting the Plant Services to the specific needs of the accelerator systems (e.g., temperature, pressure, flow rate, voltage, intensity, signal exchange protocols). The AF Ancillaries are as follows:

Water Primary Cooling Loops: The AF water primary cooling loops system is expected to manage around 19 MW of heat load. It is composed of several independent cooling units fed by water coming directly from the cooling towers ($\theta \leq 27^\circ\text{C}$). For most of them, water will be coming from turbo refrigerators providing chilled water ($\theta \leq 11^\circ\text{C}$), to control the temperature of specific components (e.g., RFQ, bunchers, RF antennas). Heat exchangers located in the cooling units ensure complete separation between the primary cooling water, which is directly connected to the components to be cooled, and the secondary water, which is connected to the cooling towers. In some cases, for the cooling of highly irradiated components (e.g., Beam Dump, scrapers), a 3-loop circuitry could be considered in order to provide safe confinement of the contaminated fluid.

Electrical Distribution System: The Electrical Power System (EPS) (in conventional Facilities) supplies power to the IFMIF Accelerator Facility. The total apparent power of all connected loads is estimated to be approximately 53 MVA. This power is provided in two forms. The AC low-voltage (3 x 400 V) line delivers power to all of the systems apart from the anode power supply of the high-power RF tube. The AC high-voltage (3 x 6.6 kV) line delivers the power to the 41-anode high-voltage power supply. Finally, the low-voltage network is constituted of a few primary electric boards supplying a set of secondary boards distributed throughout the Facility.

Vacuum Exhaust System: The Vacuum Exhaust System is in charge of extracting and transporting the gas vented from the relevant devices that are part of the accelerators to the Vent Gas Detritiation System (VDS) located in the Conventional Facilities.

Accelerator 1 Control System Interface: The accelerator instrumentation and control system (AICS) is one part of a multi-level distributed operating system environment. The AICS, operating one level below the IFMIF Central Control System and Common Instrumentation (CCS&CI), is conceived as an independent stand-alone system for each accelerator line, with shared services for safety monitoring/response and local data archiving/evaluation. The CCS&CI and the AICS are both configured to fully utilize the Experimental Physics & Industrial Control System (EPICS), which is the control system architecture that has become the standard for accelerators and other complex systems.

Gas Distribution System: The function of the Accelerator Facility Gas Distribution System is to bring service gases from the CF Service Gas System in sufficient quality, quantity, and at sufficient pressure to client systems that require such supply within the Accelerator Facility. The gases to be supplied are compressed air and nitrogen.

LHe Cryogenic unit: The purpose of the Cryoplant is to cool down the superconducting cavities and solenoids inside all the Cryomodules. In the two SRF linacs, which are comprised of 2x4 separated cryostats, the RF cavities and the solenoids are bath-cooled with LHe at 4.45 K and 0.125 MPa. The Cryoplant includes all cryogenic distribution networks and all of the cryogenic fluid networks needed to control helium mass flow rate, temperature, pressure, and storage as well as liquid nitrogen and nitrogen gas.

4.5 Design evolution

The design has evolved over recent years (and will probably continue evolving) to achieve its requirements. Design changes are performed as experience and new technologies are obtained in other facilities, when first tests are completed, or when a technology reaches a sufficient level of maturity. Moreover, cost, safety and availability requirements and guidelines highlight possible design changes. Some examples are:

- The previous ion source design was based on RF antennas, which had to be replaced every week [18]. The current ECR ion source provides better operational performance than the previous one.
- Due to the huge quantity of components and likelihood of numerous failures, the RF system design changed from fixed components to modular and easy-exchangeable boards to improve its availability performance. A huge effort was put into designing a quickly and easily maintainable system [72].
- In the last decade, the superconducting technology has evolved and emerged as a promising option for the accelerating linac. The former normal conducting linac evolved into a superconducting option in 2008 [73] as a result of the better performance results achieved in other facilities.
- The tuning system for the SRF linac cavities was based on a novel design – namely, a plunger inserted in the cavity. However, after the first tests were done in the EVEDA phase, the results were not acceptable and the design changed to a more usual tuning system: external compression [74].

Many other small changes have been made, and there are some proposals still under consideration for the final IFMIF design. Some examples are the step-like magnets for the HEFT and the solid-state alternative for the RF power system.

Chapter 5

RAMI methodology

The RAMI analyses conducted for IFMIF must reflect the design characteristics in each moment of the design process, considering its future operation and bearing in mind the experience of other facilities. To do so, the methodology considered the following points:

- *Iterative process*: match design with RAMI analyses during the design process.
- *Comparative analyses*: establish reference points, compare results obtained for IFMIF with those for other facilities, and obtain reliability and maintainability information.
- *Probabilistic calculations*: individual analyses for each system to establish requirements, to define the availability increase for each one, and to propose improvements.
- *Availability simulations*: estimate performance of the whole accelerator considering maintenance strategies and beam parameters. It is useful to foresee the future operation of the accelerator as a whole.

These aspects are explained in the following subchapters.

5.1 Iterative process

An iterative process was developed to include the RAMI analyses in the IFMIF accelerator design. In this process, the design evolution and the RAMI analyses were synchronized to achieve a high level of coherency between them. This methodology was established at the beginning of the process, linking the design with the RAMI studies and defining the tools and analyses to be done in a flexible way [75].

Iterations involve gathering information from the design, creating or updating the RAMI models, obtaining results, and analyzing them to propose design improvements. These iterations made it possible to incorporate recommendations and design change proposals coming from the RAMI analyses into the accelerator reference design. Moreover, the allocation of availability between systems and the resulting requirements were gradually adapted to the design characteristics of each system.

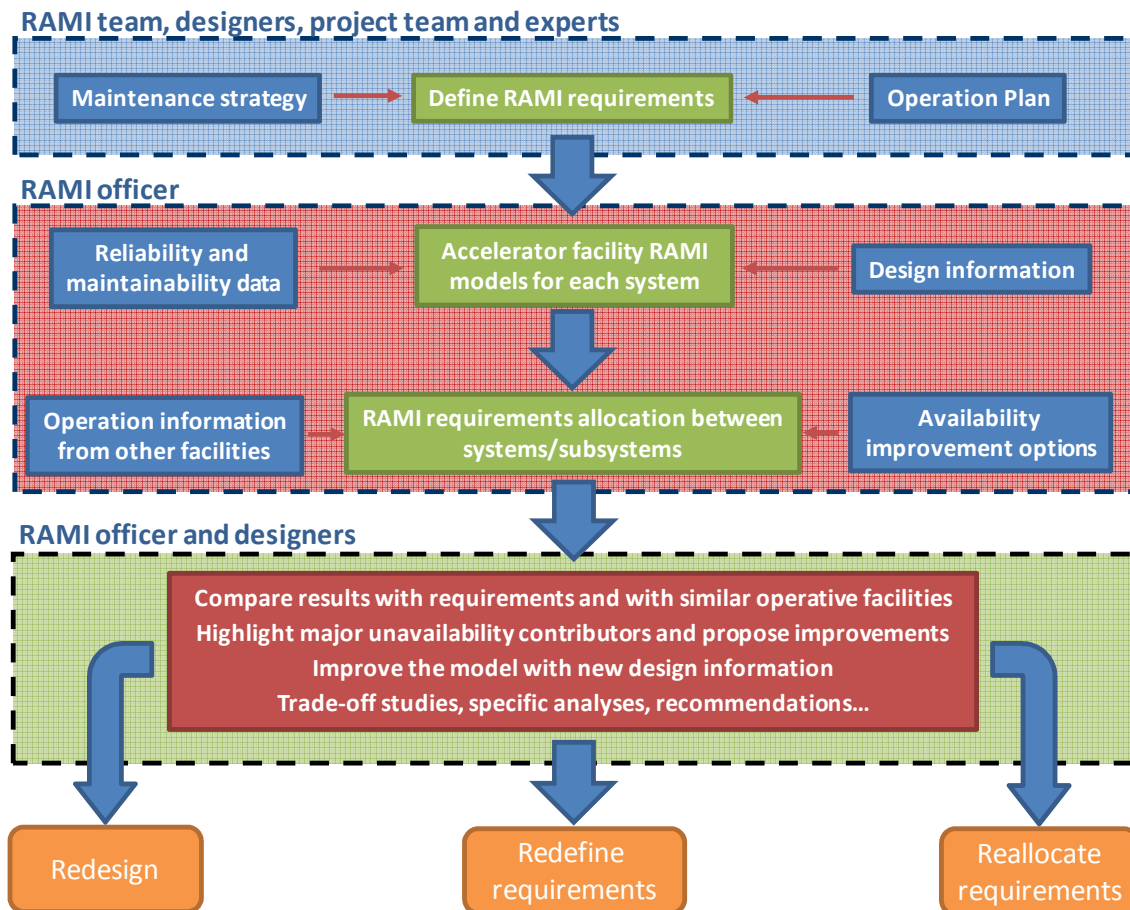

Figure 5.1 – Methodology used in the iterative process

The methodology followed is graphically represented in Figure 5.1 together with the information needed in each step and the principal actors. It basically consists in (i) defining the RAMI requirements for the accelerator facility together with different teams and experts; (ii) creating a RAMI model for each system using design information available at the moment and the reliability and maintainability data previously gathered; (iii) allocating the requirements among the systems and analyzing the results obtained with the model; and (iv) proposing changes in the design and maybe changes in the definition of the requirements or in their allocation in order to obtain coherency between the requirements, the results obtained, and the possible design RAMI performance

improvements. When this process ends, a new iteration starts using the updated requirements and the new design information.

Three iterations were performed to match the RAMI analyses with the accelerator facility design reports and documentation.

In the first iteration [76], the methodology to be used for the analysis was presented. Initial assumptions were explained, and initial results were shown. For that iteration, no redundancies or functionality were precisely described in the design, and several design assumptions were proposed. The basis of this first study was an FMEA (Failure Modes and Effects Analysis) analysis that had been developed by the RAMI team and improved upon by the designers. The data obtained were used to create the accelerator availability model with RiskSpectrum. With these initial results, the first availability allocation was done to obtain availability requirements for each system. Several possible problematic components and systems were highlighted.

In the second iteration [77], a new availability calculation was proposed in order to allow a complete availability analysis, considering all factors that may contribute to unavailability. Beam trips were considered, and beam degradations calculations were proposed. Thanks to the LIPAc design documentation, better RAMI models were achieved. Using the new parameter definitions, the new design information, and the results, the availability allocation was updated. The findings indicated that the requirements were difficult to achieve without accepting some failures in the accelerator. As a result, it was proposed to conduct a dedicated availability simulation (AvailSim) in order to consider failure acceptance and the consequent beam degradation among other features.

The results of the third iteration [78] are shown in this document and are based on the last analyses performed with RiskSpectrum and AvailSim. Beam parameter calculations proposed in the second iteration are also provided in this document. Moreover, it includes all other analyses and comparisons performed in order to obtain an analysis that is as complete as possible.

5.2 Comparative analysis

A comparison with other similar facilities was performed, focusing on generic aspects such as scheduled maintenance and operation periods, operational performance, and number of stops or beam trips. Furthermore, several comparisons were done for specific components, systems or events that have an important relevance to the availability calculations. These comparisons were performed to extrapolate operational data for the IFMIF design and to obtain other facilities' experiences in order to learn from them and obtain recommendations for the design.

Some of the results of these analyses can be seen in Chapter 9. Other results have been used as the input data for the probabilistic and simulation analyses. Moreover, generic assumptions and hypothesis done in this thesis rely on information found by means of these comparisons and extrapolations.

5.3 Probabilistic calculations

Each accelerator system was analyzed independently through fault tree models. The models were done using the commercial software RiskSpectrum® PSA Professional because it is a verified software, it is widely used in nuclear power plants, and due to the experience gathered in the NERG group over the last years.

These analyses provide availability results for each system and its subsystems, highlighting the main unavailability contributors. Moreover, some specific analyses were conducted for critical parts in order to propose possible design improvements and assess time-dependent unavailability stabilization, sensibility analyses, parametric studies and uncertainties quantification.

The aim of these analyses was to evaluate the availability of each system, compare it with the requirements allocated for them, and find weak points in the design and possible changes to improve the availability.

Models were created using the last design information obtained by the RAMI team. This information usually came from LIPAc design but taking into account the information provided by the IFMIF accelerator design and its future operation. A detailed explanation of the analyses done and the results obtained for each accelerator system is provided in Chapter 10.

5.4 Availability simulation

The whole accelerator became difficult to model with RiskSpectrum as the model grew larger and its complexity increased. When failure acceptance, beam degradation operation and first maintenance policies appeared, a simulation of the whole performance of the accelerator became helpful. An *ad hoc* simulation software makes it possible to take into consideration relevant parameters and complexities that reflect the behavior of the whole accelerator better than commercial software packages can do.

The availability simulation software called 'AvailSim', developed by the International Linear Collider (ILC) [79], became an excellent way to meet accelerator facility RAMI analysis needs. Nevertheless, this software had to be adapted and modified to simulate

the IFMIF accelerator facility in a useful way for the RAMI analyses. Furthermore, some improvements and new features were added to the software.

This software has become a great tool for simulating the peculiarities of the IFMIF accelerator facility and allowing further changes or improvements in order to obtain a realistic availability simulation. An in-depth explanation of the software and the results is provided in Chapter 11.

5.5 Other RAMI tools and analyses

To perform the RAMI analyses, other tools are used as preliminary steps or complementary studies. The principal ones are the Functional Analysis (FA), the Failure Mode and Effect Analysis (FMEA), and the Plant Breakdown Structure (PBS).

Functional analyses involve analyzing the design to extract the functions as well as the links between them. This way, the systems and the consequences of their function failures can be measured in terms of the consequence for other systems or for the machine's performance as a whole.

FMEA analyses are a very useful way to find all possible failures of the systems as well as the consequences of these failures in terms of the functions. Information about possible mitigations, ways to detect the failures, and corrective procedures can be obtained through these analyses.

The FA and FMEA studies were done during the first iteration of the iterative process and were used to develop the first model of the accelerator facility. They were developed by following the PBS in which all systems, components and subcomponents were classified. This PBS structure was defined by the project team and was followed during this process in order to establish the requirements for systems and subsystems.

In the first iteration, a draft FMECA was done in which all components and their possible consequences were included. These documents were distributed among the designers, and responsible officers of each system to improve the information conjointly. These analyses were based on the information gathered at that moment. When the design was more detailed and the analyses advanced, the new information was included in the probabilistic model directly.

5.6 Description of the methodology used in the analyses

The methodology used to make the models, analyze them, and obtain the results is graphically represented in a block diagram in Figure 5.2.

First, a frozen design or at least a partially frozen design is necessary to start analysis. With the design information, the PBS can be obtained and the failure modes and their consequences evaluated. Experiences in other facilities are used to obtain failure modes, failure rates and mean down time values and also for good practices included in the RAMI guidelines provided to the designers.

The PBS structure, the failure modes obtained in the FMEA and the failure rate and the mean downtime data are used to create the inputs for the model. These inputs are collected in a dedicated spreadsheet structure in order to import them to RiskSpectrum or to AvailSim. Assumptions and hypotheses are needed when creating the model to fill the lack of information (e.g., design, operation). Once the model created, it is improved and enhanced together with the designer’s feedback (e.g., success criteria, degraded operation, redundancies).

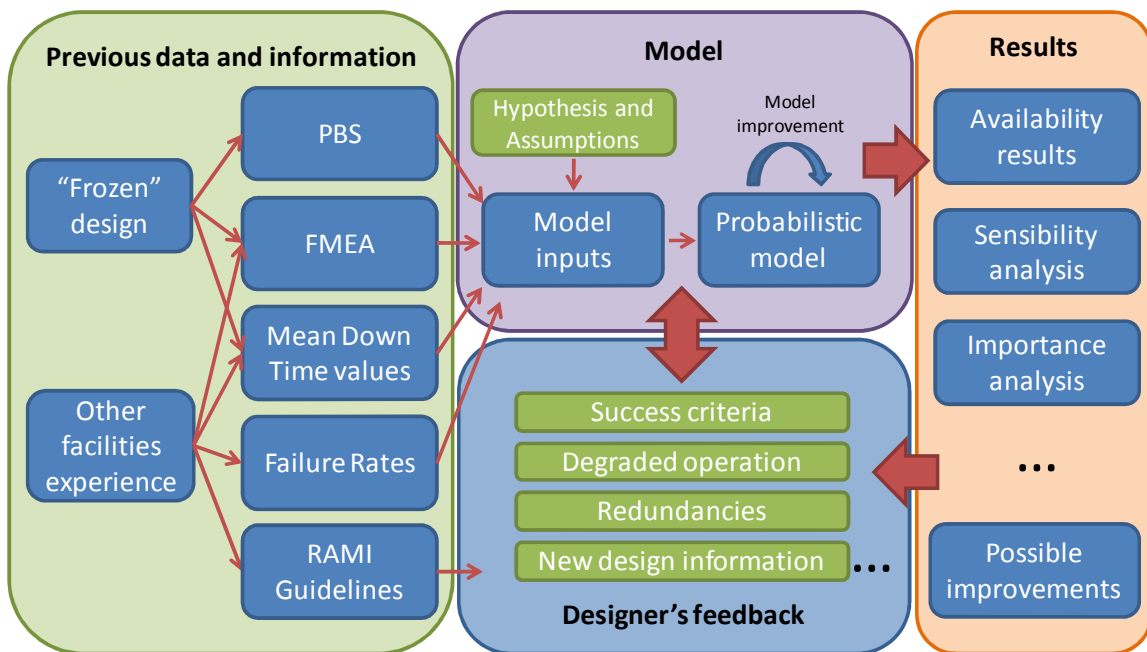

Figure 5.2 – Description of the methodology used to perform the analyses

The results obtained with the model are used to find principal unavailability and unreliability contributors through several specific analyses. Improvements or design changes are discussed together with the designers for failure modes and components highlighted by these analyses. Finally, the improvements are evaluated and proposed when feasible. Some design changes are easily included in the reference design while others need further studies due to possible cost implications or to major design changes.

Chapter 6

Accelerator facility RAMI definitions

The accelerator design and its RAMI analyses evolved over the course of this iterative process. The definitions of the availability, requirements, and ways to calculate them changed over this period to adequate them to the RAMI goals. The final definitions of the parameters and related considerations are explained in this chapter.

6.1 Specific accelerator definitions

In the first RAMI iteration, the necessity of operating with some failed components that have a degradation within the beam parameters was detected. Previous RAMI analyses did not contemplate this scenario, and the requirements and the parameters analyzed had not considered this option. New parameters were necessary in order to obtain more realistic analyses and more appropriate results [80].

Specific accelerator definitions were adopted from an International Linear Collider document [53] and adapted to the IFMIF project. The parameters used were as follows:

- **Hardware availability (HA)** is the fraction of time that the machine is available to produce a beam during the scheduled operation time. This parameter includes unscheduled repairs and all associated cool-down, warm-up and recovery times. The corresponding MDT is not only the time required to repair a failed component but also the total time the beam is off due to the fault.

- **Beam effectiveness (BE)** is the effective fraction of beam time actually delivered to the target facility. Beam inefficiencies include machine protection trips (their corresponding MDT) and beam degradation. Moreover, it should include in its considerations the fact that accelerators do not deliver the same beam continuously. The accelerator facility should provide 250 mA of deuterons at 40 MeV. Nevertheless, if these parameters are lower, the accelerator could still continue operating.
- **Beam availability (BA)** is the product of the hardware availability and the effective fraction of beam time:

$$BA = HA \cdot BE \quad (6.1)$$

HA and BA are both inherent availability parameters.

Various events that can happen in the accelerator are factored into the different parameters as follows:

- a) Components failures (or failure modes) that cause the beam to stop, requiring some repair or maintenance action (e.g., magnet failure), are considered as a hardware unavailability.
- b) Component failures (or failure modes) that have no affect due to a redundancy are not considered in these parameters. In this instance, a maintenance procedure will be needed; it can be performed while the accelerator is on, or perhaps not until the next scheduled shutdown (e.g., redundant diagnostics).
- c) Failures that degrade the beam but leave it within the acceptable range will not be considered as a hardware unavailability but decrease beam effectiveness (e.g., SC cavity tuning system). As will be explained in subchapter 8.7, the principal contributing factor to beam ineffectiveness is the intensity of the beam since it is directly related to neutron generation and dpa production.
- d) Beam trips are beam stops that need no maintenance. The MPS (Machine Protection System) is designed to stop the beam, but it is possible to restart the beam within seconds or minutes (e.g., injector sparks). These are accounted for in the beam effectiveness parameter.

As an example, in Figure 6.1, the beam is on when the machine is available (hardware availability) and when the MPS (Machine Protection System) permits to have beam. In this figure, the degraded operation of the accelerator is not represented.

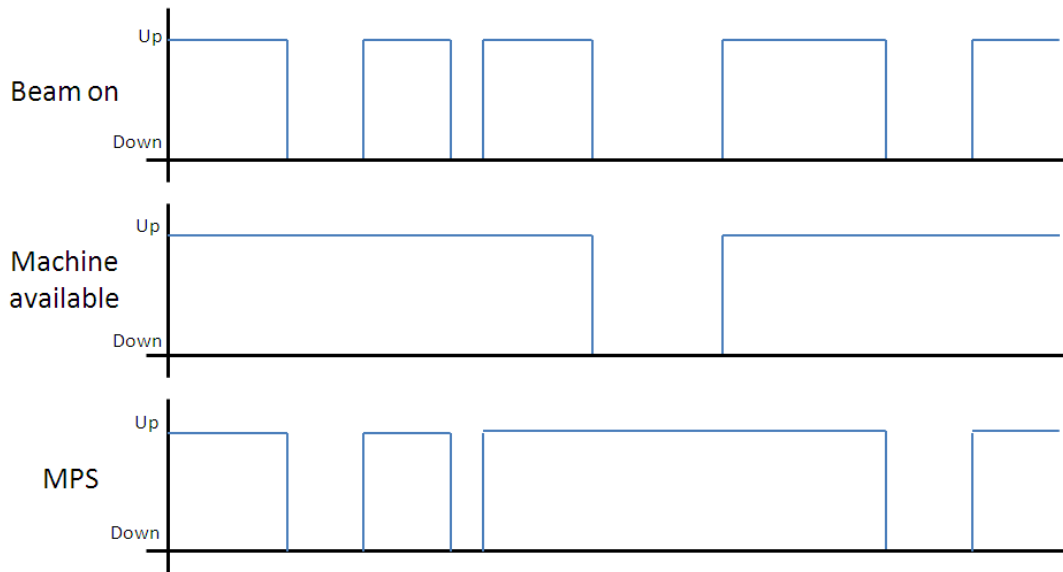

Figure 6.1 – Example of hardware availability and MPS effect on the beam

Beam trip analyses are explained in subchapter 9.3 where extrapolations from other facilities are done.

Because of these parameters, the analyses and tools (AvailSim) had to be adapted to the new inputs and outputs. The requirements for each system and the final results for the accelerator changed considerably (Chapter 7). Moreover, it was necessary to identify which components could degrade the beam as well as the consequences (subchapter 8.7) and to estimate the possible beam trips (subchapter 9.3).

6.2 Other parameters definitions

In order to quantify the contribution of each basic event to the unavailability of a system/subsystem, an importance/sensitivity analysis was performed. The definition of the parameters used in such analyses and their relationship is as follows:

- **Importance** of a basic event is the percentage of the total unavailability that is due to this single event. A low fractional contribution (FC) value indicates that a basic event has a weak influence on the unavailability, whereas a high FC value indicates a strong relationship between the basic event and the system unavailability. In this study, the FC variable was chosen to describe the importance. The FC is calculated as:

$$FC = 1 - \frac{1}{I_i^R} \quad (6.2)$$

where I_i^R is the risk decrease factor. The risk decrease factor is calculated as:

$$I_i^R = \frac{Q_{top}}{Q_{top}(Q_i = 0)} \quad (6.3)$$

where Q_{top} is the system unavailability and Q_i is the unavailability of basic event “i”. In other words, the basic event “i” does not cause system unavailability.

- **Sensitivity** is the variable that represents how the variation in the top gate can be caused by variations in the parameters of basic events. This is a reflection of each separate parameter, not considering the basic events as a whole. It has been calculated as the fraction between $Q_{top,U}$ (the unavailability of the model considering the parameter ten times higher, sensitivity factor = 10) and $Q_{top,L}$ (the unavailability of the model considering the parameter ten times lower). A low sensitivity value (the minimum value is 1) indicates that the variation in the basic parameter does not affect the global unavailability, whereas a high sensitivity value indicates that small variations in the parameter will cause high variations in the final result. In conclusion, sensitivity explains the evolution under changing parameters. Sensitivity is calculated as:

$$S = \frac{Q_{top,U}}{Q_{top,L}} \quad (6.4)$$

- **Sensitivity vs. importance** is a graphical representation of the relationship between both parameters for all basic events of a model. Its objective is to compare their relationship with the reference tendency and the coherency between them. For events with high FC, the sensitivity will be higher than for events with lower FC; however, sometimes this is not met when events have low FC but their high sensitivity may induce high downtimes. Changes in the parameters of events of components that are very repetitive in design might induce larger downtimes than expected. These cases can be found with this representation.
- **Time dependency** is used to see the evolution of the availability over the analyzed period. It is very useful to see if the mission time specified in the analysis is correct and if the results are stabilized. High failure rates with low downtimes will tend to stabilize more quickly than low failure rates and high downtimes.

Chapter 7

Accelerator facility availability requirements

The requirements established for the accelerator facility evolved together with the RAMI analyses. As explained in the previous chapter, availability parameters and their definitions changed, as did the requirements. The definition of the accelerator facility requirements, the calculation method and the allocation between the different systems are explained in this chapter.

7.1 Accelerator facility top requirements

As explained in Chapter 1, the operational availability requirement for IFMIF is 70% and the inherent availability requirement for the accelerator facility is 87%. Considering that operation with one accelerator is valid for the experiments [32] and that the requirement has been considered to be related to *dpa* (damage production), it can be assumed that:

- If both accelerators are working, maximum availability is 100%;
- If one accelerator is not working, maximum availability is 50%; and
- If none are working, availability is 0%.

With this relation between availability and *dpa*, and assuming that the accelerators are completely independent of each other, the availability requirement for each accelerator is also 87%.

7.2 Availability distribution

Accelerator facility scheduled time can be distributed among correct operation, scheduled maintenance, ineffective beam time and hardware unavailable. This is graphically represented in Figure 7.1. Moreover, hardware availability requirements are distributed among accelerator systems.

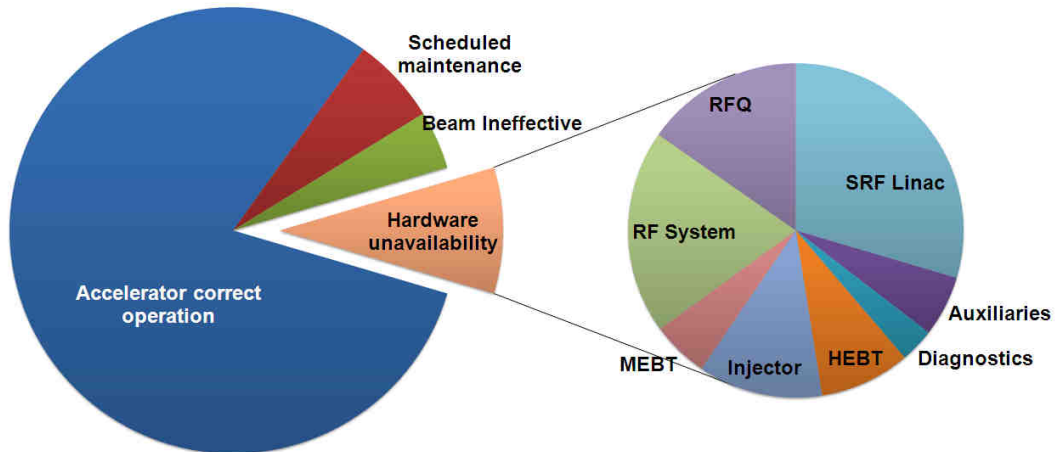

Figure 7.1 – Estimation of time distribution among accelerator modes of operation and maintenance and hardware unavailability system requirements

To obtain this distribution, first preliminary beam effectiveness estimation must be done to calculate the hardware availability in order to distribute the requirements among the accelerator systems. These steps are explained in the following subchapters.

7.3 Preliminary beam effectiveness estimation

Beam effectiveness is very complex to evaluate since it depends on technologies used, operation procedures, beam power, protection systems and facility maturity, among other factors. In a mature facility, taking into account trip rate information and trip length from operational facilities, a preliminary estimation (subchapter 9.3) showed that the time lost on beam trips would be around 200 hours annually. That means that about 2.5% of the annual scheduled operation time is lost due to these events for each accelerator.

Previous analyses indicated the necessity of operating with some degradation in the beam. For example, a failure in a tuning system of a superconducting cavity could degrade the beam but should not stop the whole facility. A preliminary rough assessment showed that, for each accelerator, the beam would be about 98% of the nominal intensity on average. This estimation was used to define the hardware availability requirements of the accelerator facility; however, since this parameter has great importance in the availability

calculation, a specific analysis was performed to evaluate the degradation achieved when some failures are accepted. Possible degradations are defined in Chapter 8, and the results obtained with RiskSpectrum and AvailSim are shown in Chapters 10 and 11, respectively.

With these estimations and assumptions, the preliminary beam effectiveness value of each accelerator will be around 95.55%.

7.4 Availability requirements and allocation

Hardware availability is the main parameter studied in these analyzes since it represents the design of the machine from the point of view of reliability and maintainability during scheduled operation. Systems design availability requirements are allocated in reference to this parameter.

7.4.1 Hardware availability requirement

As the inherent availability requirement for the accelerator facility is 87% (which is the same as the beam availability) and the beam effectiveness is 95.55% for each accelerator, the hardware availability requirement for one accelerator can be obtained by the following equation:

$$HA_{A1} = HA_{A2} = \frac{BA_{AF}}{BE_{A1,2}} = 91.1\% \quad (7.1)$$

where sub-index AF means accelerator facility, A1 Accelerator One and A2 Accelerator Two.

7.4.2 Hardware availability allocation

An availability allocation was performed to distribute the accelerator facility requirements among the different accelerator systems. Hence, each system has its own requirement, allowing detailed analysis, individual goals and the tracing of improvements.

Some allocation methodologies were evaluated and developed. Nevertheless, these procedures could not take into consideration all technical aspects, differences in design phases, or design enhancement options. Instead, model modifications were done to estimate possible availability improvements for each system.

The availability allocation was based on the results of the calculations performed in previous RAMI iterations as well as the global hardware availability requirement. This allocation evaluated the system’s capacity to increase its availability performance. To establish the requirements, possible improvements were discussed and agreed with the designers. Moreover, availability performances of similar systems in other facilities were considered to establish reference parameters. To calculate the possible hardware availability increase, specific analyses were done for each system with different configurations and considering the possible design improvements. In the following table, availability requirements for each system are presented.

HA requirement	
Auxiliaries	99.4%
Diagnostics	99.8%
HEBT	99.2%
Injector	98.9%
MEBT	99.5%
RF System	98.2%
RFQ	98.6%
SRF linac	97.2%
Accelerator	91.1%

Table 7.1 – Hardware availability requirements for each accelerator facility system

The hardware availability requirements in the table above were obtained through the results from the RiskSpectrum model in the second iteration. These requirements were established as a basis for the third iteration.

Chapter 8

Hypotheses and assumptions

Hypotheses and assumptions are essential to make models of the availability performances of the IFMIF accelerators. The lack of design and operation information in each design step has been addressed by the considerations described in this chapter. Moreover, assumptions from uncertainties, failure acceptance and operation limits are also described.

8.1 Operation and maintenance assumptions

Several assumptions are made in the maintenance and operation performance of the accelerator facility:

- It is assumed that operating with only one accelerator on for several hours is valid for the experiments. Nevertheless, a limit for operating with one accelerator should be established. If one accelerator fails for several hours, the impact and the procedure to be followed must be determined in advance. It could be possible that the other accelerator may need to be shut down and the samples would have to be cooled to avoid annealing. This has an important impact on the availability. The requirements for the accelerator facility could be higher.
- It is assumed that the operation of the two accelerators is independent. Generally, accelerator ancillaries supply each accelerator independently.

- If it is faster to change a component than to repair it after a failure, it is assumed that the component will be replaced. This will depend on the failure modes of the components.
- Remote handling was not modeled in the current analysis. Hands-on maintenance with corresponding cooling time is assumed.
- It is assumed that the vacuum is isolated between the different systems. This way, if there is a leak or failure in one of these parts, then the others are not affected.

8.2 Analysis assumptions

Several assumptions concerning the probabilistic and simulation analyses have been done in these studies:

- Taking into account the maintenance plan, the analyses are done with more than eleven months of mission time, (365 days – 23 days = 8,208h).
- The failure rate is modeled with lognormal distribution. These distributions are described with a mean (failure rate selected) and an Error Factor (EF). The strategy when selecting the proper EF was obtained from a Savannah River Side Generic Database document [81].
- The MTTR used include no statistical distribution in order to eliminate uncertainty in the analysis.
- The analyses assume that the accelerator's components reach a steady state after several years of operation. The bath tub curve (early "infant mortality" and wear-out failures) is not taken into account.
- It is assumed that preventive maintenance will be applied to components with a lifetime longer than the maintenance period.
- Availability requirements are distributed among the PBS when possible.
- Beam dump failures will not stop the accelerator in normal operation; however, if it does encounter a problem, it would be hard to restart the operation after a long downtime. As it has no direct influence on the accelerator normal operation and its failure probability is very low, it was agreed by the RAMI team that it would not be analyzed in these RAMI studies.
- Availability is calculated only for one accelerator and extrapolated to the whole facility assuming identical designs and individual and separate operation.
- The alignment system is not analyzed in these studies.

8.3 Mean Down-time assumptions

Mean down-time after a failure is composed of several operations and actions to be performed depending on the failure. An example of a generic failure detected by the MPS is presented in Figure 8.1.

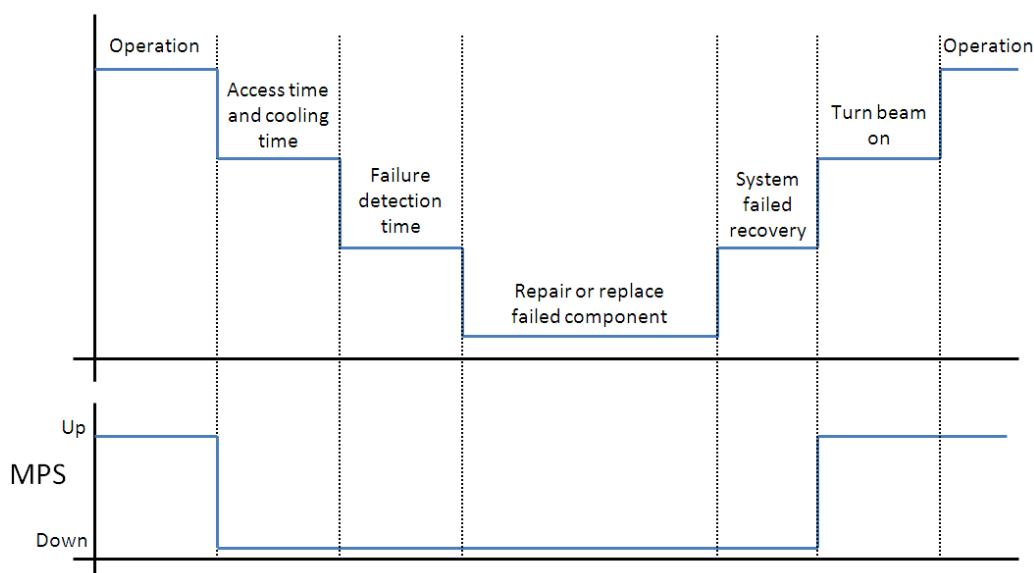

Figure 8.1 – Schematic example of time consumption operations after a failure in one accelerator

Assumptions made in each operation of the Mean Down-time are explained in the following paragraphs.

The principal equation used to obtain the MDT is as follows:

$$MDT = Detection + Cooling + Access + MTTR + Recover + Tuning \quad (8.1)$$

For each case, and depending on the type of failure, the corresponding turn-on sequence time must be added.

8.3.1 Detection time

Some failures are easy to find by using the control system. Other failures can be harder to find, e.g., bad contacts in control wires. For this reason, detection time was fixed at 30 minutes for each failure.

8.3.2 Location: Access time, cooling time

An associated access time was considered depending on the location of the failed component, and the activation cooling time. Access times from Table 8.1 were used in the RAMI analyses after receiving first data from safety calculations. Specific access times have been considered for the components whose hands-on maintenance requires a longer cooling time. For components surrounding HEBT and MEBT scrapers, cooling time has been estimated to be one week. It has been considered that no other components require extra cooling time as no safety information was obtained.

Location	Access Time	Cooling time	Maximum time
Easy access	0.5 h	-	0.5 h
Vault	1 h	24 h	24 h
BTR	1 h	36 h	36 h
RIR	1 h	42 h	42 h
TIR	1 h	72 h	72 h

Table 8.1 – Location access and cooling times

8.3.3 Components: MTTRepair, MTTReplace, Logistics

It is assumed that the MTTRepair is the same time that it would take a maintenance team to repair the component in the repair shop. MTTReplace is used in instances where the component needs to be changed. If this is the case, there would be a logistic time associated with the time required to obtain a new component. This time would be lower if a spare has been prepared. It is possible to consider hot spares for some components in order to reduce the time required to replace the component. In this thesis no logistics times have been considered. The MTTR information can be found in the Appendix B (in electronic format).

8.3.4 System to recover: Recover Time + Tuning Time

Depending on the system affected by the failure, there will be an associated time to recover the system (e.g., cryogenics or vacuum system). Some of the generic data used are shown in Table 8.2.

System to recover	Recover Time	Tuning time	Total
Cryomodule (Open it)	336 h (2 weeks)	2 h	338 h
Cryomodule (Medium)	720 h (1 month)	2 h	722 h
Cryomodule (To clean room)	1,800 h (2.5 months)	2 h	1,802 h
Vacuum system	6 h	1 h	6 h
Water cooling	2 h	1 h	3 h
Beam focus components	-	3 h	3 h
RF system	-	1 h	1 h
Local control system	1 h	-	1 h

Table 8.2 – Recovery time

Other specific data was used for especial components or systems without generic considerations.

8.3.5 Turn-on sequence

The turn-on sequence depends on the state of the different systems and how long the system has been off. In this section, a rough estimation is performed. Considering that all systems are ready to start the sequence, the steps required to turn on the beam are shown in Table 8.3. This sequence was done together with the accelerator designers.

Step	Step description	Time approx.
1	Bring up support systems (e.g., controls, insulation vacuum, diagnostics, cooling).	1 d
2	Cool down superconducting sections of the accelerator. In this step, the injector will perform the steps required to prepare to send the beam (15 hr). It can maintain this position for as long as it needs with the faraday cup inserted in the beam pipe.	3 d
3	Adjust the currents of superconducting magnets to nominal values.	< 1 h
4	With CW RF operation, adjust RF feeds for nominal cavity amplitudes and phases (no beam).	< 1 min
5	Tune to 40-MeV beam, using beam-line diagnostics and feedback from instrumentation in the high-energy beam calibration station. The beam position, RF phase and amplitude as well as HEBT optical elements will be corrected during these tests. Beam in low duty cycle.	4 h
6	Switch magnetic optics to deliver the beam to the lithium target. Confirm the beam characteristics and position from previous observations with feedback from target diagnostics.	< 2 h
7	Extend pulse width and pulse rate until full current CW operation is achieved while continuing to monitor the beam using target diagnostics.	< 8 h

Table 8.3 – Current general steps of beam turn-on

Each system should have their own turn-on sequence in case they lose their functions and the functions provided by other systems. Some details are explained for each system in Chapter 10.

8.4 Generic design assumptions

Some design changes or improvements were assumed to be implemented in the reference design. These design changes were found in the first and second iterations. This makes it possible to focus the analysis on further design characteristics, problems or possible improvements. Some of these assumptions are defined in this chapter; others are explained in the analysis of each system, in the probabilistic RAMI analysis in Chapter 10.

IFMIF accelerator design is mainly based on the LIPAc prototype design and extrapolated to IFMIF characteristics. In some cases, due to the lack of information about the final IFMIF design, the number of components and their functionality was assumed.

8.4.1 Water cooling systems

The water cooling system is assumed to be in the accelerator auxiliaries and the conventional facilities. Each accelerator system will have its own water cooling distribution system, but not the pumps or heat exchangers. The RFQ is an exception, as the water cooling system is used for RFQ tuning.

8.4.2 Power supplies

It is assumed that an easy way to disconnect a failed component and connect a spare one has been prepared for all power supplies. This could easily be done with flexible cables and a prepared spare to enable fast manual replacement. Modularity and power supply standardization should be required.

8.4.3 Control system

a) Instrumentation

It is assumed that single failures of instrumentation components will not stop the machine. It must be foreseen that failures in such components will occur and their consequences should be minimized. Redundancies have been considered.

b) Machine Protection System

In order to minimize the number of unexpected trips, to minimize consequences of failures in these systems, and to achieve an acceptable machine safety level, it has been assumed that a 2-out-of-3 voting system has been prepared. This means that sensors whose signal will stop the machine are assumed to be included in triplicate. Thus, a single failure in any one of these components will not imply to stop the accelerator.

For example, the flow switch and temperature switch of the magnet cooling systems are assumed to utilize such a voting system. These small cheap elements should make it possible not to stop the accelerator unless there is a real problem.

It is important not to impose overly restrictive threshold levels in order to distinguish between the detection of a possible problem and a need to stop the accelerator. For this reason, two thresholds are recommended: one to detect and the other to stop. A planning to determine optimal thresholds should be foreseen. Beam trips are assumed to be lower than the nominal ones because such optimization is assumed to have already been done.

c) Personnel protection system

During operation, there is no possible access to the vault and, it is assumed, no possible access to the RF system room. The personnel protection system should not stop the machine during operation. Shutdowns due to PPS or failures in its system have not been modeled in the RAMI analysis.

8.5 Reliability data used

Several assumptions were made to allow the creation of a RAMI model of such a machine. Some components' failure modes were impossible to find, so approximations were done. Moreover, some components and even systems had not yet been defined in the design, and generic failure rates were used.

Several optimistic assumptions were made in the data selection in order to remain coherent with the design, fabrication and quality control expected for such a machine.

It is important to note that the results obtained in this document may be realistic if the reliability of the components is similar to that used in the models. Components and systems should achieve the reliability value proposed in these analyses; otherwise, the availability requirements will not be met. The reliability data used should be considered as requirements for the components.

It is expected that, in the next years, more reliability data will be available for accelerator facility components. The reliability database used should be revised in future

analyses. A data capture methodology was specifically developed for IFMIF in [32]. The data obtained in prototypes (mainly LIPAc) should be carefully gathered according to this methodology.

The failure rate and mean time to repair data used was partially obtained from previous studies performed in the Fusion Energy Engineering Laboratory at Universitat Politècnica de Catalunya. The FEEL reliability database [30] was merged with ENEA's fusion component failure rate database (FCFR-DB) [82], which is supported by the European Communities under the contract of the Association between EURATOM and ENEA within the framework of a F4E contract and an ITER Task Agreement. The overall activity of data collection and analysis was also set within the frame of the International Energy Agency (IEA), Task 5. Reliability database used in these analyses can be seen in the annexes.

8.6 Uncertainties

RAMI analyses have several sources of uncertainty. Some are quantified (e.g., failure rate distribution), but there are many others that cannot be quantified or are not yet known. These two different sorts of uncertainty are defined as follows:

- Aleatory uncertainty: “inherent variation associated with the physical system or the environment under consideration” [83].

- Epistemic uncertainty: “any lack of knowledge or information in any phase or activity of the modeling process” [83].

Uncertainty quantification is the science of quantitative characterization and the reduction of uncertainties in applications [84]. Its goal is to reduce epistemic uncertainties in order to obtain aleatory uncertainties.

The aleatory uncertainties calculated in the RAMI analyses of IFMIF are only the ones coming from the failure rate distribution of the input data and from the Monte Carlo simulations. On the other hand, there are several non-quantified sources of uncertainty in the RAMI analysis of the accelerator facility. Some examples are:

- **Design definition:** This could be assumed to be similar to the Cost Estimation classification [85]. In the design phase of the accelerator facility, the level of estimation was classified between levels 2 and 3 in the AACE classification [86]. This means that many uncertainties should be considered from the design point of view.
- **Accelerator operation and maintenance characteristics:** Operation, maintenance, beam turn-on sequence, access times, logistics and manpower, to name a few, are not yet clear. The availability of the whole system depends upon these parameters.

- **Data used:** Failure rate and mean time to repair data used in these analyses might differ from the actual performance of the components and systems. These differences could be decreased if more operational data were gathered from other facilities. Moreover, differences in operation modes, conditions and environments can change component's reliability values.
- **Model accuracy:** The model used is very detailed but not excellent due to its lack of design information, time and resources. Moreover, the model used was accomplished through fault trees using the RiskSpectrum software. As the design became highly detailed and the model increased in complexity, some details could not be correctly modeled with this technique, leading to an increase in some uncertainties. For this reason, dedicated software was developed based on the *International Linear Collider's* software called AvailSim for the accelerator facility (Chapter 11). With this software, some possible uncertainties arising from the model were eradicated.

Consequently, the results achieved by these analyses cannot be taken as precise and accurate values. There are other parameters and uncertainties not yet known that could appear when the design becomes more detailed, the operation becomes clearer or better reliability data is obtained; however, the mean values obtained are very helpful to estimate availability performance and to highlight which components and systems will induce more downtime.

Uncertainties are not propagated to results in this document because few aleatory uncertainties are known at this moment and there are huge epistemic uncertainties that would cause results to fluctuate considerably. It would not be coherent to include uncertainties in the results without considering the other possible contributors, which are not possibly known at this design phase. Results are given with the mean value obtained with RiskSpectrum or AvailSim in order to be able to compare them with the requirements and other design options. Uncertainties should be quantified and dismissed in future analysis.

8.7 Failure acceptance and beam degradation

Although, for most components, a failure will impose the need to stop the accelerator, for some of them, a retuning of components around can allow operation with degraded performance.

The following failure acceptance and degradation analyses were conducted jointly by the beam dynamics team, accelerator system designers and RAMI team. Three different kinds of parameter degradation have been considered in this analysis: intensity, energy and beam shape.

8.7.1 Operation limits

The following limits are considered acceptable for the correct operation of the accelerator.

8.7.1.1 Energy

The nominal beam energy is 40 MeV. It is assumed that the minimum energy acceptable for the target and test facilities is 38 MeV. Consequently, some failures that lead to operating with less energy can be accepted.

8.7.1.2 Intensity

It is assumed that operation with less than nominal intensity is accepted by the users; however, beam intensity is assumed to be directly related to the number of dpa produced. Beam availability is related to dpa production and, therefore, to beam intensity. Consequently, if the beam intensity is too low, it may be preferable to repair the failed components than to continue in a degraded mode of operation. This decision will depend on the intensity degradation, the down-time required to repair the component and the remaining time to the next scheduled maintenance period.

The mean down-time required to repair the components that degrade the beam intensity is between 2 weeks and 2 months. Depending on the remaining time to the next scheduled maintenance, the minimum degradation acceptable on the beam intensity will differ. This is illustrated in the following figure:

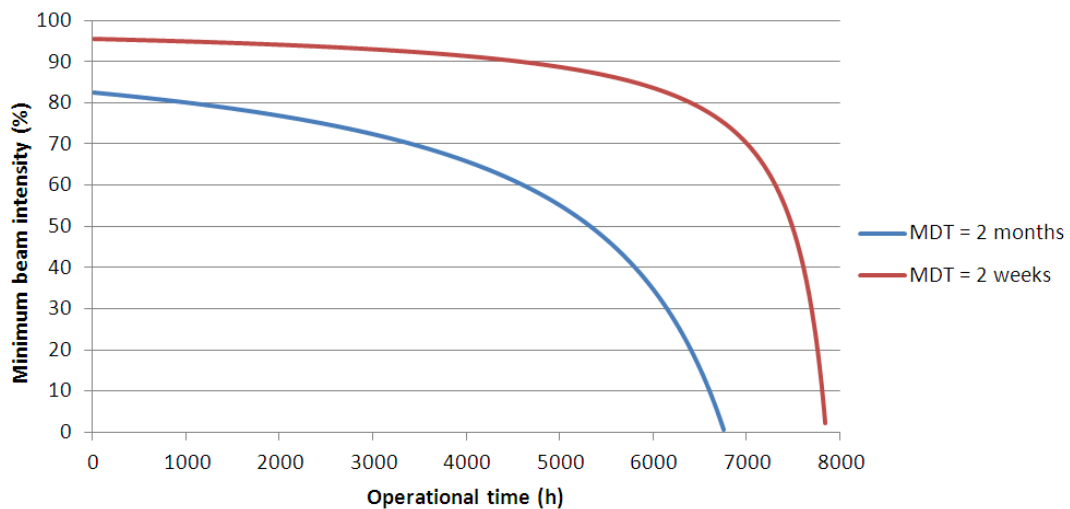

Figure 8.2 – Minimum intensity of beam required to continue operation instead of performing maintenance

For failures that occur at the beginning of the operational year, it would be preferable to perform maintenance than to continue operation. If failures occur at the end of the operational year, it may be preferable to continue operation even in a significantly degraded mode than to stop the machine. These maintenance policy characteristics were implemented in the AvailSim simulation and could not be directly modeled with RiskSpectrum.

8.7.1.3 Beam shape

Beam shape fluctuations could be problematic for the target lithium loop; thus, further studies should be done to identify possible implications in each case. Some beam shape degradation is assumed to be acceptable in these studies considering that the impact on the beam distribution will not be high.

8.7.2 Failures per system

For each system, the possible acceptable failures and their implications for the beam parameters are shown.

8.7.2.1 SRF linac

a) Complete Cavity Failure

Several failures can lead to this case (e.g., cavity damaged, no RF power supply). If such a failed cavity can be completely detuned, then it is transparent to the beam, as if no component were there. The consequences are a lack of acceleration and a lack of defocusing effect.

The beam focusing can be easily compensated for by the nearby solenoids; however, as the periodicity of the structure is broken, the beam halo will increase. In response, a decrease of the beam intensity should be planned.

In this instance, the energy of the beam would be lower, but if the other cavity fields can be increased and re-tuned in phase, then the energy could be compensated. Each cavity has some electric field margin. Conservative estimations assume that the total energy overhead that the SRF linac can supply is about 1 MeV. Therefore, the energy can be compensated up to 1 MeV. In cases where more than this amount of energy is missing, the beam will have less energy than the nominal value. The energy decrease depends on the energy that the failed cavity was supplying. The energy supplied by each cavity to the beam is roughly estimated in Table 8.4.

	# Cavities	E_{in} (MeV)	E_{out} (MeV)	Energy per cavity (MeV)
Cryomodule 1	8	5	9	0.500
Cryomodule 2	10	9	14.5	0.550
Cryomodule 3	12	14.5	26	0.958
Cryomodule 4	12	26	40	1.170

Table 8.4 – Energy beam degradation depending on cryomodule

Cavities in the first part of the SRF linac will be more problematic than in the last part. In order to reduce losses to an acceptable level, the required intensity reduction will be higher in the first cavities and lower in the last ones. A failure of the first cavity of the first cryomodule would require operating with 80% of the beam intensity, but a failure in the last cavity of the last cryomodule would not imply any intensity reduction. A simple linear law can be assumed for the other cavities, depending on their location. Figure 8.3 shows the possible resulting intensity for each single cavity failure.

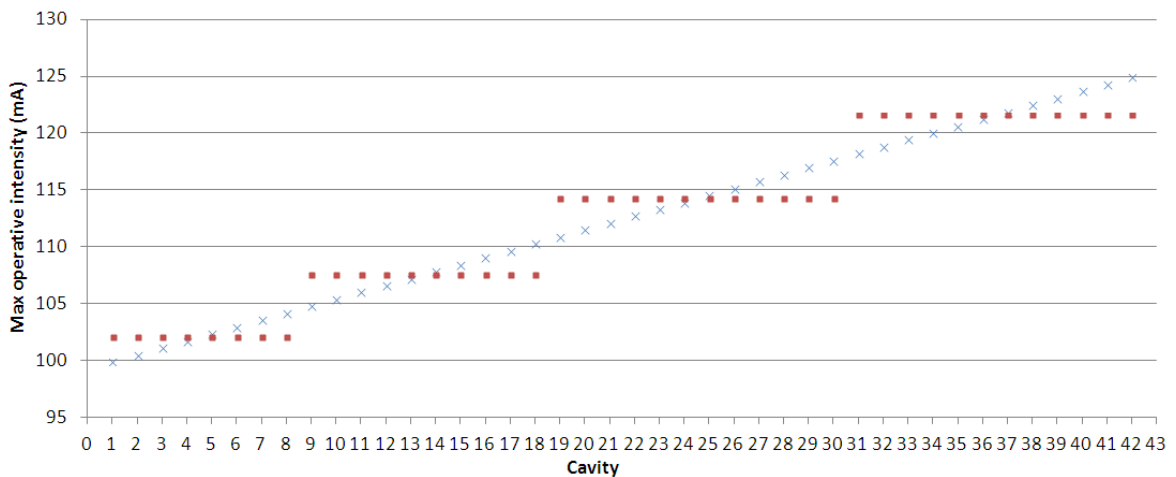

Figure 8.3 – Maximum operative beam intensity approximation depending on the failed cavity

	Cryomodule 1	Cryomodule 2	Cryomodule 3	Cryomodule 4
Max intensity	102.1 mA	107.6 mA	114.3 mA	121.6 mA

Table 8.5 – Maximum operative beam intensity in case of failure in SRF linac cavities

It is considered that even in the event that many cavities fail, there is no need to reduce beam intensity beyond 80% as periodicity has already been broken; however, as discussed above, a lack of more than 1 MeV cannot be compensated, and in this case a beam with less energy will be provided. Moreover, if one failed cavity cannot be detuned, then the beam could be decelerated.

b) Failure in the cavity tuning system

A failure in the cavity tuning system can be induced, for example, by a mechanical problem in the stepping motor, in the mechanical transmission system, or in the power or control system of the stepping motor. The principal consequence is the inability to tune the cavity (not even detune it completely in the event of total failure). This will mean that the RF power provided at the right frequency is not correctly transmitted to the beam.

The RF power could be increased to compensate the lack of power if an adequate margin is available. The cryogenic system should also be able to extract more power than in the nominal situation. If the cavity is far from the resonant point, it will be more difficult to compensate the lack of power and thus the lack of beam energy.

The intensity degradation will also depend on the cavity position, but as it is less important than a cavity complete failure, it has been estimated to be half of its degradation (like in Section 'a' but with 90% for the first cavity, up to 100% for the last one). As in the case of cavity failure, even in the case of many tuning systems failing, there is no need to reduce beam intensity beyond 80%.

Intensity and energy degradation assumptions:

	Energy loss	Maximum intensity
1st tuning failure	$-\frac{E_{cavity_a}}{2}$	Depending on the position/2
More than one tuning failure	$-\frac{E_{cavity_a}}{2} - \frac{E_{cavity_b}}{2} - \dots$	Tuning failure 1 position/2 + Tuning failure 2 position/2 + ...

Table 8.6 – Energy decrease in case of failure in one or more cavity tuning systems

c) Solenoid failures

In the transverse plane, the solenoids focus the beam and the accelerating cavities defocus it. Some first beam dynamics simulations showed that even if a solenoid is not operative, it is still possible to operate the accelerator if the following cavity is switched off and detuned in order to avoid its defocusing effect. If not, the defocused beam becomes more expanded and induces important losses before reaching the next solenoid.

When a solenoid fails, it is still possible to continue operation, but the intensity of the beam will be reduced to 80%, because the beam occupancy is now much closer to the pipe wall. The energy of the beam will be decreased due to the cavity being switched off in the same way as in Section a (i.e., complete cavity failure).

It is impossible to continue operation with two successive failed solenoids; however, the failure of two non-successive solenoids, if far enough from each other, may possibly be handled as described in Table 8.7.

The energy and intensity parameters for the first and second solenoid failures are:

	Energy reduction	Intensity
1st solenoid failure	Energy of the cavity switched off	80%
2nd solenoid failure	Energy of the cavities switched off	50%

Table 8.7 – Maximum operative beam intensity in case of failure in SRF linac solenoids

d) Steerers failure

If there is a failure in a steerer (one plane), it is possible that the beam is not properly centered on the beam axis. In this case, neighboring steerers could be used to compensate. As a conservative assumption, it should be possible to operate with a steerer failed in each cryomodule if the beam intensity were decreased by as much as 115 mA.

8.7.2.2 LEBT

From the beam dynamics point of view, no failure is acceptable. Any failure will lead to stopping the accelerator and repairing the failed component.

8.7.2.3 MEBT

a) Bunchers

Both bunchers are considered to be essential in order to be able to operate the accelerator with acceptable conditions.

b) Quadrupole failure

If there is a failure in one of the quadrupoles, it is assumed that operations could continue if the beam intensity were reduced to 70% of the nominal performance and the accelerator were adequately re-tuned. To do so, the polarity of the quadrupoles may need to be changed.

c) Steerers

One failure per plane of the four steerers is assumed to be acceptable if the intensity is reduced to 115 mA.

8.7.2.4 HEBT

a) Triplet quadrupole failure

If one quadrupole of a triplet (three triplets) fails, the operation can continue, but the intensity must be reduced to 70% of the nominal performance and the beam shape would be incorrect. One failure per triplet was accepted as an acceptable beam shape.

b) Other quadrupoles

It is impossible to continue operation with one of these quadrupoles failed.

c) Dipoles

Dipoles are essential for the accelerator operation.

d) Steerers

There are 20 steerers (two planes each) in the HEBT. If there is a failure in up to 3 of them, and if these components are not consecutive, then it is assumed that the operation can continue with the intensity decreased to 115 mA.

e) Octupoles and dodecapoles

Failures in these components do not mean that the accelerator is unable to operate but that the beam shape will be inadequate. Further studies should be done to identify the implications that such failures could have on the other facilities. In these analyses, no failures have been accepted for these components.

8.7.3 Summarizing table

The previous failures and the consequences on the beam are summarized in the following table:

System	Component	Number of failures	Maximum intensity	Energy reduction	Beam shape degradation
SRF linac	Cavity	First	Depending on the position	- E of the failed cavity	No
		Second or more	Depending on the positions	- E of the failed cavities	No
	Tuning system	First	Depending on the positions/2	- (E of the failed cavity/2)	No
		Second or more	Depending on the positions/2	- (E of the failed cavities/2)	No
	Solenoid	First	100 mA	- E of the switched off cavity	No
		Second	62.5 mA	- E of the switched off cavities	No
	Steerer	One per plane per cryomodule	115 mA	No	No
MEBT	Quadrupole	One	87.5 mA	No	No
	Steerer	One per plane	115 mA	No	No
HEBT	Quadrupole in a triplet	One per triplet	87.5 mA	No	Yes
	Steerers	Three failures per plane, non consecutive	115 mA	No	No
	Multipoles	One or more	125 mA	No	Yes

Table 8.8 – Summary of the consequences of failures on the beam parameters

8.7.4 Multiple failures

In order to be able to conduct simulations of the accelerator performance with AvailSim (Chapter 11), some generic assumptions are considered in the case of multiple failures and multiple degradations:

- If there are multiple failures in different subsystems or different kinds of components, then the degradation in beam intensity and energy will be the sum of all degradations. For example, if there is a failure in a cavity of the first cryomodule (-22.9 mA and -0.5 MeV), and in a solenoid of the fourth cryomodule (-25 mA and -1.17 MeV for the cavity switched off), then the beam intensity would be 77.1 mA and the energy 39.33MeV (the 1 MeV of energy overhead would be exceeded).
- Multiple failures in SRF linac cavities (both complete cavity failures and tuning system failures) would not decrease the beam intensity below 100 mA. On the other hand, the energy would decrease with each additional failure. For example, if there is a failure in a cavity of the first cryomodule (-22.9 mA and -0.500 MeV), and in a tuning system of a cavity in the third cryomodule (-5.35 mA and -0.479

MeV), then the beam intensity would be 100 mA instead of 96.75 mA. The energy of the beam would be 40 MeV because the 1 MeV of energy overhead would not be exceeded.

- Failures in non-consecutive systems (or systems that have different consequences on the beam) will not require an additional decrease of the beam intensity. Only the worst failure will be taken. For example, a MEBT quadrupole failure (-37.5 mA) and a HEBT steerer failure (-10 mA) will require to reduce the beam intensity by 37.5 mA. Therefore, the intensity value would be 87.5 mA instead of 77.5 mA.

8.7.5 Other failure acceptance issues

Other systems could require a reduction of beam parameters in order to enable operation until the following scheduled maintenance period. For example, the RFQ trip rate could be increased due to some dust in the modules' vanes or due to other unexpected factors. If the intensity is decreased, the trip rate could decrease. That would degrade the beam, but it could be possible to operate without such trips. These cases are not considered in this analysis but should be studied in future analyses.

The time required to retune the beam has not been specifically considered in the availability analyses; however, it should be noted that this event will occur only few times per year. From SNS experience [87], the retune time was estimated to be 0.25 hours.

8.7.6 Beam degradation and failure acceptance conclusions

More beam dynamic studies should be done to estimate more precisely the consequences of failures on the beam behavior. In the commissioning phase, an accelerator tuning database should be created to have an automatic tuning procedure for common failures. This would help to ensure that such failures can be accepted with reasonable beam degradation and would allow faster machine tuning during the IFMIF operation phase increasing the availability.

Implications of such degradations on the availability of the accelerator as a whole are analyzed roughly with RiskSpectrum (Chapter 10) and more closely with AvailSim (Chapter 11). A comparison of the results for both analyses is also provided in Chapter 11.

Chapter 9

Comparison with other facilities

IFMIF operation and maintenance policies adopt an industrial approach aimed at dpa production in the samples. Large operation cycles, short maintenance periods and optimized RAMI and logistics performance are required to achieve the availability requirements.

The inherent availability requirement is on the order of same magnitude as the other accelerators (considering that beam trips do not decrease the availability). However, IFMIF's operational time is much larger and maintenance periods much shorter than in other facilities. Therefore, unprecedented challenges arise also from the operating and maintenance points of view.

In this chapter, a comparison is drawn to availability, maintenance and operation performance of other facilities. Moreover, specific comparisons and extrapolations are done to complement the probabilistic and simulation analyses performed in Chapters 10 and 11. Information about beam trips and cryomodule refurbishment are gathered, analyzed and extrapolated to the IFMIF accelerator case.

9.1 Availability in other facilities

As mentioned in [53], there is insufficient data available from similar projects to make plausible direct availability comparisons between facilities. Moreover, direct comparisons between accelerators are difficult due to differences in technologies, operational

performance, and beam power among others. Nonetheless, it is interesting to compare the performances of individual systems.

Usually, when accelerator facilities give the availability results of their machines, they are talking about the availability of the accelerator during the scheduled operation period, i.e., the inherent availability. Therefore, it is very important to know the scheduled maintenance periods and the annual operation time.

On the other hand, some accelerator facilities consider their availability to be the fraction of time during which their machines are generating a beam with regard to the scheduled operation time without considering huge problems or large periods of unavailability due to failures. Some examples can be found in [88]. Sometimes, these facilities have availabilities even above 100%.

Tables 9.1 and 9.2 provide information on beam and hardware availability performances from different operational accelerators facilities. This information was obtained from [53].

	FNAL		SLAC					LBL	TJNAF
	Tevatron		SLC	PEP inj	PEP-II	PEP-II	SPEAR	ALS	CEBAF
	HA (%)	BA (%)	HA (%)	BA (%)	HA (%)	BA (%)	BA (%)	BA (%)	HA (%)
Cryogenic plant	98.8	-	na	na	na	-	na	-	98.8
PS & Magnets	92.6	-	-	98.0	98.0	-	97.8	-	94.2
RF	95.2	-	-	99.1	99.1	-	98.3	-	95.7
Utilities	98.3	-	-	98.0	98.0	-	99.3	-	97.3
Vacuum	98.1	-	-	99.7	99.7	-	98.7	-	99.1
Controls	99.1	-	-	97.8	-	-	-	-	99.5
Other	98.5	-	-	-	-	-	-	-	81.9
Percent up-time	82.0	50.0	81.1	92.8	94.8	71.5	94.2	96.0	70.0

Table 9.1 – Beam availability and hardware availability in other facilities (Part 1) [53]

	CERN			DESY			KEK	ANL
	LPI	SPS	LEP	HERA	TTF	TTF	KEKB Inj	APS
	BA (%)	BA (%)	HA (%)	HA (%)	HA (%)	BA (%)	BA (%)	BA (%)
Cryogenic plant	na	-	97.8	98.6	97.5	-	na	na
PS & Magnets	99.7	-	99.7	94.8	100	-	99.5	98.8
RF	98.7	-	98.5	96.5	98.0	-	98.6	99.0
Utilities	99.7	-	-	99.5	99.0	-	-	99.8
Vacuum	-	-	99.5	99.1	99.8	-	-	99.3
Controls	99.7	-	99.7	99.7	98.8	-	99.0	99.5
Other	99.6	-	93.3	94.1	96.0	-	97.5	98.4
Percent up-time	97.4	55.0	98.2	83.4	89.5	75.0	94.0	95.0

Table 9.2 – Beam availability and hardware availability in other facilities (Part 2) [53]. BA stands for ‘Beam Availability’ and HA for ‘Hardware Availability’.

Tables 9.1 and 9.2 are useful to see what contribution each system makes unavailability in each facility; however, it is very difficult to extract any general conclusion from these data. Moreover, it helps illustrate the difficulty of comparing the hardware availability and beam availability parameters of different facilities.

Other information found in [89]: “Some recent annual machine availabilities are SNS – 86%, PSI- 85 to 90%, ISIS – 88% (average 1998-2008), LANSCE/Lujan centre – 85%, FNAL – 95% (Main Ring only), and J-PARC – 92% (annual average not available for J-PARC, this is for 5 recent runs)”. It was concluded that “it is difficult to exceed 90% availability for extended periods with high-power machines, and also operate more than 5000 hours/year” [89].

“PSI and ISIS have approached this level, but no high-power facilities have been able to maintain >90% availability for any extended period of years. All facilities tend to have lower availability at the start of extended run periods” [89]. It is therefore of the utmost importance to consider machine operational cycles when calculating an accelerator’s availability.

Another important aspect that can be seen in Tables 9.1 and 9.2 is that the beam effectiveness assumed in Chapter 7 will be hard to achieve. This is even more difficult since beam trips increase with beam intensity [90,91]. However, it has been noted in other facilities that when dedicated effort is put into machine protection systems to avoid these problems, significant improvements are achieved [92].

Availability decreases with the beam current but increases with facility maturity [93], as can be seen in Figure 9.1. This can be very important for the IFMIF accelerators due to the high beam current:

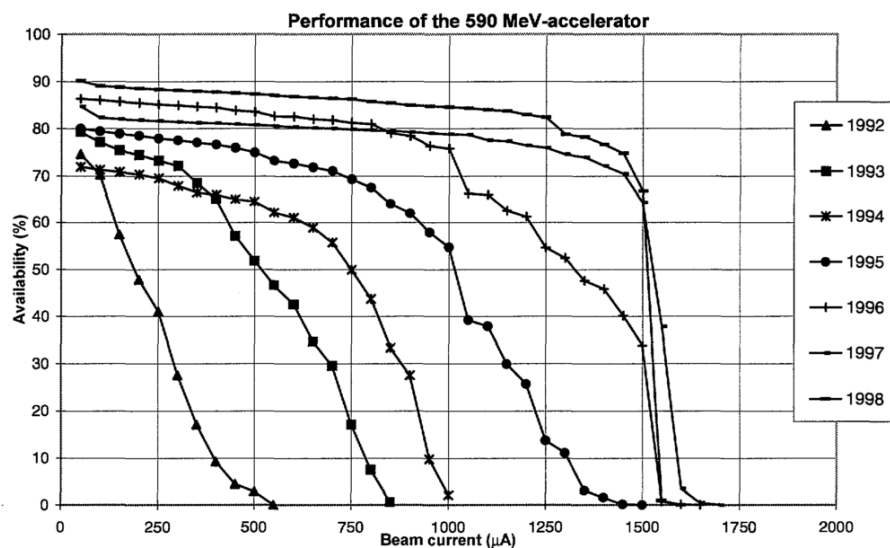

Figure 9.1 – Availability of beam fed to the meson production targets as a function of the beam intensity as developed since 1992 at PSI [93]

Based on the information regarding generic availability data that was obtained from operational accelerators, the conclusion is that design, maintenance plans, operation cycles, beam parameters and availability definitions and facility goals must be considered in order to make proper availability estimations or comparisons. For this reason, the information shown in this chapter cannot be directly linked to IFMIF availability but can be used as a reference.

9.2 Operation and maintenance plans in other facilities

Taking into account the IFMIF maintenance plan described in Chapter 1, the accelerator scheduled operation time is around 8,208 hours per year. Compared with other accelerators (PSI 5,600 h, SNS 4,900 h, LANSCE 3,300 h [89] and LHC 5,110 h [38]), IFMIF’s operation/maintenance plan is highly exigent.

Facility	Annual scheduled operation time
PSI	5,600 h
SNS	4,900 h
LANSCE	3,300 h
LHC	5,110 h
IFMIF	8,208 h

Table 9.3 – Scheduled operation time for similar facilities

Operation and maintenance plans are key aspects of availability estimation analyses. A review of the operation and maintenance of accelerator facilities was done in [94]. This document states that “all high power accelerators require machine maintenance, as well as beam study time. One consideration is the time required to restore high power operations after a major shutdown (i.e., one month or more). The responses are generally one to a few weeks.” Any maintenance action must take this tuning time into consideration. Some examples are [94]:

- PSI takes 2-4 days for tuning + 4 days equipment readiness.
- ISIS and the FNAL Booster and Main injector take about 1 week per month off.
- LANSCE schedules 1 month for recovery, which includes equipment readiness, RF conditioning, equipment certification processes, and beam tuning. This is done once per year.
- SNS is in its infancy and presently schedules 10 days after 4-7 weeks of extended maintenance, but it sometimes takes longer to re-establish a reliable beam.

In [94], the common operation and maintenance cycles are also gathered. “A consequence of the difficulty in restoring high-power beam operations after long shutdowns has been the tendency for facilities to schedule the beam to remain on for extended periods to avoid this difficulty.” Common run cycles for different facilities are shown below [94]:

- PSI schedules 3 weeks of production separated by 2-3 days for beam studies and maintenance.
- ISIS has a 50-60 day cycle consisting of about 40 days of production, 3 days of beam studies, a 10-day short shutdown and a 10-day startup.
- LANSCE has a one-month cycle with 24 days for production, 1-2 days of beam studies, 4-13 days of maintenance, and one day of recovery.
- FNAL-NUMI has 10-14 weeks of shutdown per year, and runs the beam until component failure.
- SNS is adopting a 3-week run cycle with 16 days of production and 5 days of beam studies and maintenance.

As seen in [89], “the consensus is that longer runs with fewer scheduled extended maintenance periods are preferable, if possible.”

These run cycles are very different from those proposed for IFMIF. In order to achieve the availability requirements, IFMIF accelerators have proposed few scheduled maintenance periods per year and large operation periods. The only way to be able to operate during these long periods is with an extremely fault-tolerant design.

9.3 Beam trips data gathering and extrapolation to IFMIF

Beam trips will be a very frequent event in the IFMIF accelerator facility, occurring several times a day. It has been considered that any non-scheduled beam shutdown that does not arise from component failure is a beam trip (if it is not necessary to perform maintenance). This includes sparks in the injector or the cavities, RF trips, quenches, etc. It can also be caused by a sensor that stops the machine for a real problem, for a spurious signal, or for an overly conservative threshold.

At this moment there are no reliability requirements for the IFMIF accelerator facility, only the ones derived from the availability requirements. The objective of this subchapter is to estimate an order of magnitude of the number of trips that the IFMIF accelerator could have in normal operation. IFMIF target and test facilities designers can use this information to foresee possible implications of beam trips. Moreover, the unavailability

contribution of trips into the beam effectiveness parameter is calculated. To do so, some trips information from other facilities have been gathered and analyzed. Finally some conclusions and possible extrapolations to the IFMIF accelerator facilities are shown.

9.3.1 Data gathering

Thanks to the effort done for the ADS (Accelerator-Driven Systems), in order to meet their reliability requirements, the beam trips of some facilities were compiled. In an ADS document [61], it can be seen that the four facilities studied have a notorious quantity of beam trips for each trip duration range. This is why the ADS designers are developing procedures and improving the design in order to decrease the number of beam trips and improve the availability [58].

The data shown in Figure 9.2 was obtained from [40,94]. The data is from high-power proton accelerators that have some similitude with IFMIF. As can be seen in Table 9.3, the power of these accelerators is lower than the nominal power of IFMIF, the mode of operation is not a continuous wave in some and the energy is different (from 70 MeV to 1 GeV). Nevertheless, this information can allow us to know the order of magnitude of beam trip rates and duration.

Data used in these analyses come mainly from the following facilities:

Facility	Location	Type	Particle	Kinetic energy	Beam power	Intensity average
SNS (Spallation Neutron Source)	Oak Ridge National Laboratory	Linac/accumulator ring (Pulsed)	H-	1GeV	1,4MW	1,4mA
ISIS	UK	Synchrotron (Neutron source)	H-	800MeV	180kW	0.23mA
LANSCE	USA Los Alamos National Lab	Linac (Pulsed)	H+/H-	800MeV	0,8/0,08MW	1,0/0,1 mA
PSI	Switzerland	Cyclotron (CW)	H+	590MeV	1.2MW	2.2mA
Lujan (LANSCE)	USA Los Alamos National Lab	Linac (Pulsed)	H+	800MeV	0.1MW	0.125mA
CEBAF	Jefferson Laboratory	Linacs (CW)	e-	6GeV	0.9MW	0.15mA

Table 9.4 – Accelerator facilities analyzed

As said in [94] by the author of some of the data used: “Any comparison of these quantities between different institutions is an inherently uncertain business due to differences in accounting rules.”

The upper and lower bound that will be used to analyze the beam trips for the IFMIF accelerator facility have been added in the following graph:

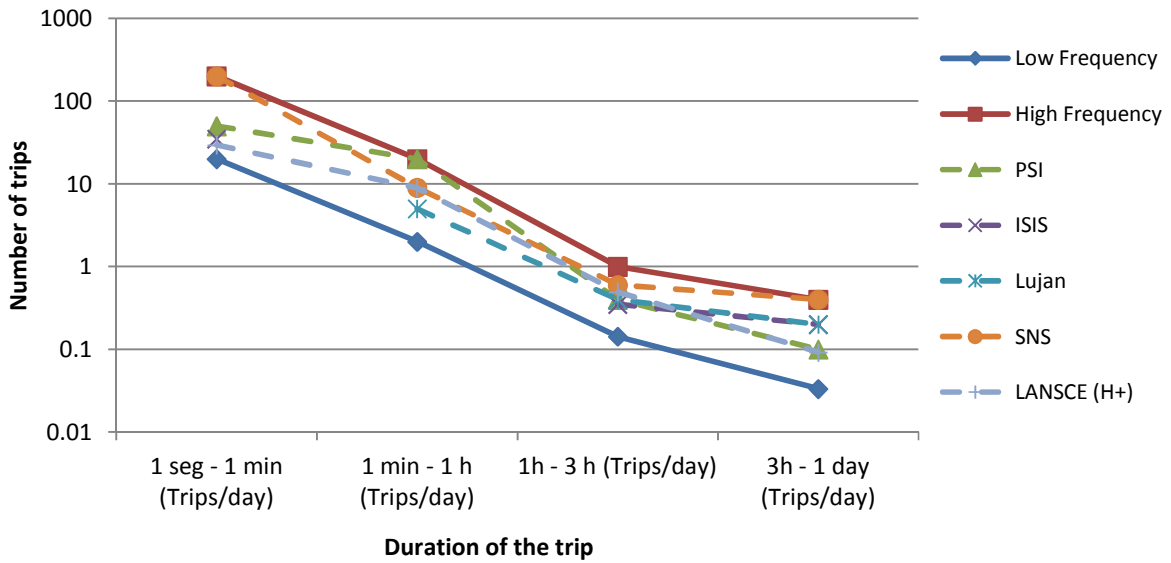

Figure 9.2 – Beam trips vs. trip duration for high-power proton accelerators [40,94] and IFMIF high and low estimated frequencies.

It was assumed that the trips per day were accounted for 24 hours of continuous operation. In this kind of facility, trips with a length between one second and one minute occur between 30 and 200 times a day. Trips with a length between one minute and one hour occur between 2 and 20 times a day. Trips with an outage between one hour and three hours have a frequency of less than one per day but more than one per week. Finally, trips with a length of more than three hours have a frequency of around once a week.

Other specific information from other facilities was also found. The information is shown in the following subchapters.

a) CEBAF

In CEBAF, the requirements of the experiments are to keep the RF trip rate below 15 per hour of operations [95]. Each CEBAF cryomodule had an average trip rate between 516 trips and 579 trips per year.

b) ADS requirements

The principal reference in studying the number of trips is the ADS design. An ADS study determined that the number of trips would be roughly around 21,000 per year in a future ADS facility [96]. These requirements are far below the trip rates of current accelerators. The ADS designers are identifying many improvements that would be needed in order to meet such challenging requirements. It is interesting to see that efforts

are being made to decrease the number of trips and their duration, and that significant improvement is expected [59,97].

9.3.2 Important parameters for the trip rate

The experience obtained at LEPP-II [91] is that “operate at the maximum beam energy, the experiments had to tolerate a very high frequency of RF trips. The trip rate was about 2 per hour at 98 GeV rising to about 4 per hour at 100 GeV. Above 5 mA, the trip rate rose even higher. Most trips occurred mainly due to field emission so that in-situ processing played a crucial role”.

In LHC, fault density depends strongly on beam intensity and integrated luminosity as described in [90].

Increasing the power in the IFMIF accelerators will increase the trip rate. As there are no accelerators as powerful as IFMIF, the trip rate should be assumed to be high and therefore some preventive actions should be taken to decrease the frequency of these events and the repercussion in IFMIF operation.

9.3.3 Extrapolation to IFMIF

In order to make a detailed extrapolation, many parameters and design characteristics should be taken into account. The kind and number of components, the operation parameters, the maintenance plan performed, and the facility maturity should be analyzed in order to gather the information and extrapolate it for IFMIF in a detailed way. Since there is no facility like IFMIF, and since the data with which the comparison is performed lacks sufficient maturity, the extrapolation here is just a rough estimation.

Further analysis should be done for each system and subsystem. Such analysis could yield specific information for each system operating in specific conditions.

It is assumed that the design will be improved over former designs by using good practices and preventing the problems that have been identified; however, taking into account the increase of energy and intensity, the trip rate could be at least in the same order of magnitude as the facilities analyzed in Figure 9.2.

a) Number of trips and length for each accelerator

Some estimation has been done in Table 9.5 using the data from other facilities shown in this chapter and the data of the RAMI analysis of the IFMIF accelerator facility.

The number of trips has been estimated with the accelerator reliability analysis and the availability requirements.

Nevertheless, the estimation was made in a conservative way from currently available data. In order to be conservative enough, the data obtained from other facilities have been used for each IFMIF accelerator rather than using them for the accelerator facility as a whole. A huge effort has to be made to obtain more reliable and accurate data. Assuming an operation of 24 hours a day, the trip estimations are as follows:

Event duration	Low frequency	High frequency
1 sec - 1 min	20 per day	200 per day
1 min - 1 hr	2 per day	20 per day
1 - 3 hr	1 per week	1 per day
3 h - 1 day	1 per month	1 per week
TOTAL	1 trip/hr	9 trips/hr

Table 9.5 – Trip estimation for each IFMIF accelerator

b) Beam characteristics

In order to estimate the beam characteristics, some assumptions were made. First, it is considered that the availability requirements are met; assuming that each accelerator's inherent availability is 87%. It has been assumed that beam trips are short enough to be negligible for the unavailable annual time (it is valid for the trip rate estimation). Furthermore, operation with only one accelerator on is considered to be valid for the experiments.

With each accelerator capable of achieving 87% availability, the probability that both accelerators will be down simultaneously at a time when they are scheduled to operate is 0.0169. Hence, over many years of operation, both accelerators are expected to be down simultaneously for an average of 139 of the 8,208 hours of their operating schedule each year. The period of time with only one accelerator on would be considered as 50% availability for RAMI analysis.

Considering the availability requirements for each accelerator and the annual operation time of 8,208 hours (365 days minus 20 days of long maintenance minus 3 days of short maintenance), the accelerator facility operation states will be as follows:

- Both accelerators ON: 6,074 hours annually (74.00% of the annual time)
- One accelerator ON and the other OFF: 1,995 hours (24.31% of the annual time)
- Both accelerators OFF: 139 hours (1.69% of the annual time)

With accelerator operation states and beam trip frequencies, the beam received by the lithium target can be roughly extracted.

- Trip rate for beam change from 250 to 125 mA

The beam intensity will decrease from 250 to 125 mA when there is a transition from operating with two accelerators to operating with only one due to a trip or failure in one of the accelerators. These transitions will take place for trips that occur when both accelerators are on; approximately 74% of the time. Therefore, the trip rate can be extracted as shown in Table 9.6. Large beam trips were removed because frequency can be neglected.

Event duration	Low frequency	High frequency
1 sec - 1 min	40 per day	400 per day
1 min - 1 hr	4 per day	40 per day
1 - 3 hr	2 per week	2 per day
TOTAL	2 trips/hr	18 trips/hr

Table 9.6 – Beam trip rate from 250 to 125 mA of beam

- Trip rate for beam change from 125 to 0 mA

When one accelerator is off due to a long failure or a maintenance procedure, any failure or trip in the operative accelerator will stop the beam completely. This happens approximately 24.31% of the annual time (1,995 hours). The trip rate will be for only one accelerator:

Event duration	Low frequency	High frequency
1 sec - 1 min	20 per day	200 per day
1 min - 1 hr	2 per day	20 per day
1h - 3 hr	1 per week	1 per day
TOTAL	1 trip/hr	9 trips/hr

Table 9.7 – Beam trip rate from 125 to 0 mA of beam

9.3.4 Beam trips' unavailability contribution

The unavailability contribution of such trips was estimated taking into account the most frequent trips and the estimated average trip duration. Larger beam trips will be considered as failures and therefore not included in this table:

Event duration	Average duration	Low frequency	High frequency	Availability (Low)	Availability (High)
1 sec - 1 min	10 seconds	20 per day	200 per day	99.77%	97.67%
1 min - 1 hr	10 min	2 per day	20 per day	98.61%	86.11%
1 - 3 hr	1.5 hr	1 per week	1 per day	99.11%	93.75%
TOTAL				97.50%	78.84%

Table 9.8 – Beam availability due to beam trips

In order to achieve a coherent analysis in hardware availability calculations, the unavailability of each accelerator beam is considered to be 2.5% of the scheduled time. This value could be assumed as a requirement in the RAMI point of view for future analyses.

9.3.5 Beam trips conclusions

The information in this chapter provides a rough estimation of beam trips frequency, and duration in order to detect any possible problems that could arise in the test or target facilities due to these beam trip rates. The goal is to identify any reliability requirement that could be demanded to the accelerator facility. Moreover, this estimation has been used to determine the beam ineffectiveness caused by such trips.

Beam trips can contribute significantly to unavailability. The number of trips and the duration should be decreased as much as possible. The goal of diminishing these parameters should be considered in the design phase of all accelerator systems. Several documents and papers give recommendations on how to decrease the beam trips [98,99]. Experience from high-power accelerators can help obtain an improved design [92,100].

9.4 SFR linac: data gathering and comparison with IFMIF

SRF linac has been the system that contributed most significantly to the accelerator unavailability in first and second RAMI iterations. Efforts have been made to find possible errors in the calculations and also possible improvements in the design. A comparison with other SRF linacs was done to extrapolate the data obtained from other facilities to the case of IFMIF.

9.4.1 Introduction

At first sight, it might seem that SRF linac systems do not contribute significantly to unavailability in other accelerator facilities [95,101]. As it is said in [92], “SRF and related support technologies account for a relatively small amount of downtime. The average down-time reported by the laboratories was equivalent to 3.7 percent of the time that the accelerator was in operation.” This could seem low, but this would not be enough to achieve the high availability requirements of IFMIF (SRF linac hardware availability requirement is 97.2%).

In this subchapter, a deeper analysis of such results and the way in which these values are obtained is shown. Also, a comparison between the operational data obtained in other facilities and an estimation of unavailability caused by cryomodule refurbishments for the IFMIF SRF linac is done.

9.4.2 Relevant aspects for availability calculation

a) Failure acceptance

As stated in subchapter 8.7, failure acceptance is very important to accelerator availability and especially for the SRF linac. In some machines, it is possible to continue operations with some failed components. For example, a cavity or a magnet failure (depending on the importance of the failure) could eventually be compensated with other components. In these cases, the accelerator continues operation until the next scheduled maintenance period, at which point the failed components are fixed. In such cases, the downtime caused by the failed cavities or magnets is zero and the availability is not decreased.

Since the SRF linac has a huge downtime to repair the failed components, the capability to continue operation until the following maintenance period is of the utmost importance.

In the case of IFMIF, it is more difficult to accept failures because all components are needed due to the high beam requirements; however, it could be possible to operate with a degraded beam and wait until the next scheduled maintenance for repairs.

b) Scheduled operation period

IFMIF’s scheduled operation time is around 8,208 hours per year. As seen in this Chapter, compared with other accelerators IFMIF’s operation plan is highly demanding. Moreover, because there are less maintenance periods in the IFMIF operation plan than in

other facilities, it would be more difficult to arrive at the maintenance period without any failures or with few acceptable failures.

c) Maintenance implications in availability

In IFMIF, the long period of scheduled maintenance is 20 days. The time required for large maintenance actions in a SRF linac cryomodule will be about 2.5 months. This means that even if it were possible to continue operation with some failures in the cryomodules, when the maintenance period arrives, the time to repair the cryomodule could be longer than 20 days; therefore, it would decrease the accelerator's inherent availability (which does not happen in many accelerators because they have longer maintenance periods).

9.4.3 Operational data from other facilities

The data used to make this analysis came from [92]. The principal facilities where this information was extracted were the SNS, CEBAF, LEP-II, TTF and KEK-B.

As explained in [92], "Integrated SRF operating experience can be measured using the Cryomodule Century, or CC. Ten cryomodules operating for a decade, or 50 of them operating for two years, yield 1 CC".

The operational data showed that "in CEBAF's decade and a half of operating, about 1.5 refurbishments have been necessary per CC" [92]. Moreover, in the same document it is said that "CEBAF had one cryomodule failure per CC, but the failures appeared only after the first 7 years, or the first 3 CC. The failures exposed flaws but new problems are surely coming. CEBAF has also had gradient degradation of 1% per year from new field-emission sites caused by particulates inside the vacuum system. In sum, from CEBAF experience, any SRF machine needs to plan for refurbishments at a rate of 1–2 per CC." [92]

In SNS [102], "different SCL operating problems have been identified and over the last few years, repairs were attempted to recover performance to cavities in 4 of the 23 installed cryomodules." These repairs were:

- CM19: "This cryomodule was moved to the clean room and procedures were developed to vent and repair the cavity."
- CM12: "Beam-line leak and cryomodule limited by field emission," "Failed HOM ceramic feed through," "During the cool down, it was identified that an additional cold leak on the helium circuit was appearing."
- CM10: "Cavity with a noisy field probe signal. The problem was a loose cable."
- CM09: "Cavity which had a tuner that was running excessively," "The tuner motor, harmonic drive replaced and the piezo tuner removed."

In SNS, “plans are now being made to repair CM11 cavity b (the last remaining cavity not being operated in the SCL) failed HOM coupler during the February maintenance period 2009” [102].

Moreover, in SNS “there are seven cryomodules with known insulating vacuum leaks and have additional turbo pumps installed on them in the tunnel. Data suggests that four of the seven have outside to insulating circuit leaks, two are helium circuit to insulating circuit and one is unclear. Most leaks can be repaired in the tunnel but the helium circuit leaks will require an available spare cryomodule before they can be removed from the tunnel and repaired in the RF Test Facility” [102].

With these examples, it seems probable that failures in IFMIF cryomodules will occur. Therefore, refurbishment of cryomodules should be planned and spare components studied.

9.4.4 Design and complexity comparison of SRF systems

As the data obtained is mainly gathered in terms of cryomodule century, a comparison between the cryomodules should be made to estimate the relationship between IFMIF cryomodules and those of other facilities.

The IFMIF SRF linac design was mainly compared with that of SNS [103,104] and CEBAF [104,105], despite the fact that the cavity types and cryomodule designs are completely different. Because these cryomodules were the ones from which data was obtained, they will be called *reference cryomodules*.

A rough comparison showed that the IFMIF cryomodules are about 3 times more complex (i.e., with more components) than the reference cryomodules. It is assumed that in terms of reliability (cryomodule refurbishment), there is a direct relationship; therefore, the reliability of one IFMIF cryomodule is the same as that of 3 reference cryomodules.

One IFMIF accelerator has 4 cryomodules, which in terms of complexity and reliability could be compared to 12 reference cryomodules. For both accelerators, it would be comparable to 24 reference cryomodules.

It should be noticed that some diagnostics and other components, like steerers or solenoids, are outside the cryomodule in many accelerators. Due to IFMIF intense beam, beam dynamics requirements do not tolerate any drift tubes without focusing or acceleration. As a result, all components are inside the cryomodule, which could require more cryomodule refurbishments.

9.4.5 Comparison calculation and results of cryomodule refurbishments

A cryomodule refurbishment consists of extracting the cryomodule from the beam line, moving it into a clean room and making some important maintenance action. In the case of the IFMIF, the time required to perform such activity was estimated as 2.5 months. The reason for such maintenance actions can be component failure or, as in CEBAF, “gradient degradation of 1% per year from new field-emission sites caused by particulates inside the vacuum system” [92].

It is considered that each IFMIF accelerator has the equivalent to 12 reference cryomodules, and that each accelerator will be operating continuously for 30 years, with an annual operation of more than 8,200 hours; the number of CCs (cryomodule centuries) accumulated will be around 3.5.

With the operational data obtained from [92], two refurbishments per CC could be conservatively expected. As a result, for one IFMIF accelerator, about 7 refurbishments should be expected over the whole IFMIF lifetime. This would mean having a very long maintenance period (about 2.5 months) every 4 or 5 years of operation.

If each refurbishment lasts 2.5 months, and there will be 7 refurbishments in the 30 years of operation, the availability would be that which is displayed in Table 9.9. Two scenarios were considered since maintenance operations can be done on the long maintenance period (75 days minus 20 days = 55 days lost) or through non-scheduled maintenance (75 days lost) (Table 9.9).

This availability value would mean that the requirements for the SRF linac (97.2%) would not be accomplished. It is very important to note that failures of support systems or failures that allow maintenance to be done without extracting the cryomodule are not counted in such results; therefore, the requirement for this event should be considerably higher.

	Total time lost	Availability
Refurbishment during the long scheduled maintenance period (55 days)	385 days	96.2%
Refurbishment without scheduled maintenance period (75 days)	525 days	94.9%

Table 9.9 – Availability and downtime if MDT=2.5 months

In order to improve the availability for this case, hot spare cryomodules should be prepared to substitute the failed ones. The estimated time to change the cryomodule and be able to operate again is about 20 days. The results in such cases are:

	Total time lost	Availability
Refurbishment during the long scheduled maintenance period	0 days	100%
Refurbishment without scheduled maintenance period (20 days)	140 days	98.6%

Table 9.10 – Availability and downtime if MDT=20 days

Here, the availability requirement could be accomplished in both cases.

9.4.6 Design optimization in terms of RAMI

A SRF linac design with smaller cryomodules would allow easier maintenance actions. Few spare modules would be required if these modules could be standardized. This design improvement would reduce logistic activities and the cost of spare cryomodules. This option would require a complete re-design of the SRF linac, and should be analyzed in future studies.

9.4.7 SRF linac comparison conclusions

Operational data from other accelerators show that failures in SRF linac cryomodules will occur several times in the IFMIF’s lifetime. As there is no scheduled maintenance period for cryogenic components and the downtime for such events is very high, from what can be seen in this comparison, either the availability requirements will not be achieved or hot spare cryomodules will be needed.

This is just a comparative analysis, but as it is said in [92], “despite the uncertainties, strategies for spares will need to be developed.” Due to IFMIF’s high availability requirements, it should not happen the same as in SNS: “For SNS there is an additional burden in that there are currently no spare cryomodules and this makes developing new in-situ methods of repair a must to keep the installed components healthy while the spares are being designed and produced” [102].

From the availability point of view, it is very important to decrease the downtime lost to maintenance actions: “If extrapolation from current operating experience is valid, it will be important to have the ability to refurbish, which means that it will be necessary to avoid having cryomodules that are difficult to extract. It is the continuation of a longstanding design conflict: tight integration of systems improves performance, but makes repair harder.” [92].

Chapter 10

Probabilistic analyses

Each system was analyzed independently using RiskSpectrum fault tree models. The analyses are shown in this chapter and include the model description, specific assumptions of the system, and availability results for the system and subsystems. Moreover, some specific analyses were done to find major contributors and to propose possible design improvements.

The aim of these analyses was to evaluate the hardware availability of each system, compare it with the requirements allocated for each one, and find weak points in the design as well as possible changes to improve the availability. For this purpose, statistical analyses were conducted to evaluate time dependency, parameters and events importance, sensitivities and uncertainties.

These analyses were done in all RAMI iterations. The results obtained in the first and second iterations were used to improve the design and the availability results. It would have been nearly impossible to describe and measure the consequences of the RAMI studies on each system in each design step due to the parallel evolution of both tasks. Thus, only the results of the third RAMI iteration are shown in this chapter.

Two different models are described in these analyses: the reference design model and an improved design model. The reference design model includes some improvements assumed in the first and second iterations. Such assumed changes were suggested with the consent of the designers and seemed easily applicable. More important changes are proposed for the improved design model.

Due to the iterative approach used, many models have been constructed for each possible design improvement, for design modifications or for more detailed inputs. Because of the high number of components and events analyzed, an enormous quantity of

inputs had to be introduced in the model each time. For this reason, an automatic procedure was developed to create the RiskSpectrum database and model outside the software itself through a spreadsheet and several visual basic scripts. This burdensome task made it possible to change the whole model and database quickly and efficiently.

Some additional tools were needed to create a realistic model since Riskspectrum is not perfectly adequate for the required RAMI analyses of the IFMIF accelerator. To construct the probabilistic models of some systems, data treatment and adaptation were needed.

The data used to develop the reference and the improved design models are shown in the Appendix B (in electronic format).

10.1 Injector

The LIPAc injector prototype and documentation made it possible to have very good information for the development of a detailed RAMI model. Visits were made to CEA Saclay to see the prototype and improve the model.

An extended analysis was done during the first and second RAMI iterations in the master thesis of Gonzalo Martinez Hinojosa [106]. A development of the FMEA, a comparison with other ECR ion sources, and a model including the information found were done. The analysis served as the basis of the analyses shown in this subchapter.

10.1.1 Comparison with other Injectors

Tests performed in other facilities are very interesting from the ECR source operational point of view. The ECR sources most similar to the IFMIF one are:

- SILHI (from CEA-Saclay) [22]
- Spiral 2 ECR source (also tested by CEA-Saclay experts) [107,108]
- LANL pulsed ECR proton source [109]
- LEDA proton source (also from LANL) [110]
- TRIPS (TRASCO Intens Proton Source) [111]

Table 10.1 shows the parameters of the 5 ECR source in comparison to the IFMIF source.

Parameters	IFMIF ECR	SILHI EC	LANL Pulsed ECR	LANL (LEDA) ECR	TRASCO (TRIPS)	Spiral 2 ECR
Energy [keV]	100	95	47	75	80	40
Current [mA]	125	120	65	117	30	5
Duty factor	CW	CW	Pulse mode	CW	CW	CW
Test duration [h]	-	744	170	168	142	-
Emittance [$\mu\text{mm-mrad}$]	0,25	0,25	0,2	0,2	0,2	0,2
Particle type	D ⁺	D ⁺ /H ⁺ **	H ⁺	H ⁺	H ⁺	D ⁺
Microwave freq. [GHz]	2,45	2,45	2,45	2,45	2,45	2,45
Microwave power [kW]	1,2~2	0,8~1,2	0,57	1~1,5	2	2
Availability [%]	-	97-99,8	96,2	98	98**	-

Table 10.1 – Comparison of ECR source parameters. *No CW operation with D⁺ (0.2% duty cycle), limited by neutron production. ** at 35 mA.

ECR ion sources have higher reliability and availability performances than previous ion source technologies. Longer duration tests should be run to assess its long-term operation performances; however, tests done with other current injectors seem very promising.

10.1.2 Model description

The injector system is mainly modeled following the PBS structure. Failures in this system normally imply to stop the beam. Injector components are all located inside the vault except for some ancillary systems. This implies an additional access time of about 24 hours to perform any maintenance actions that may be needed.

The model structure is as follows:

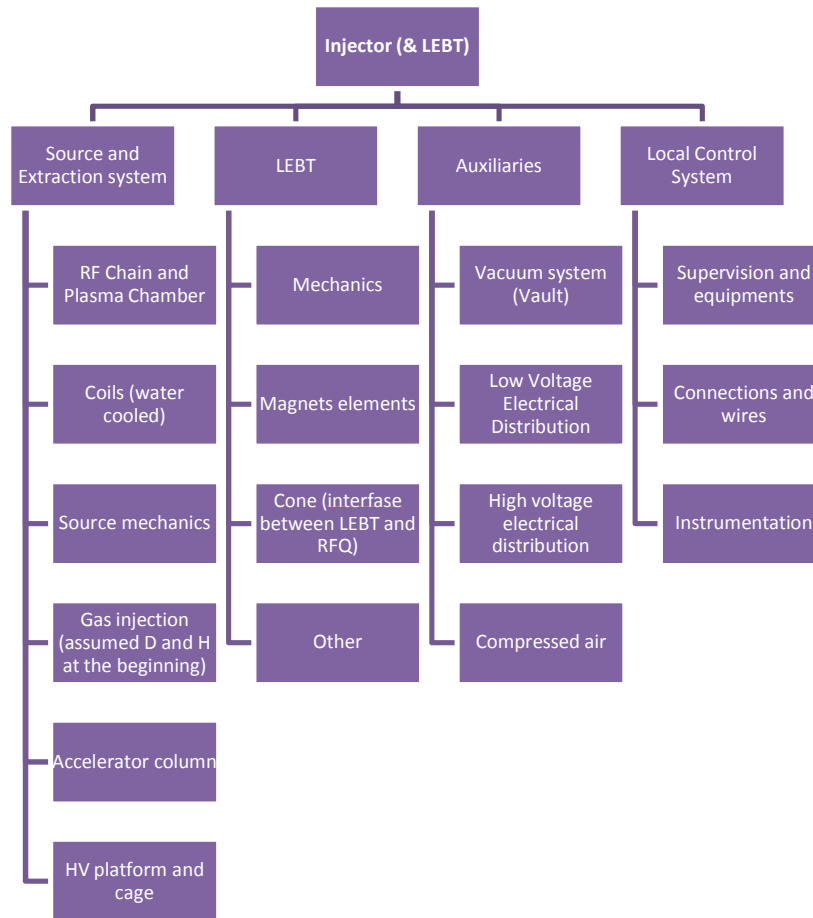

Figure 10.1 – Injector model structure

10.1.3 Assumptions

a) Maintenance and operation assumptions

Boron nitride disks need to be changed twice per year due to wear out. These components are not considered in the hardware inherent availability analyses because they will be replaced in the short scheduled maintenance period without any unavailability consequence. Noteworthy, this maintenance period was specially planned for the replacement of these components. Otherwise, they would be considered as critical components for the injector system.

In order to enter to the vault area, it has been assumed that 24 hours of cooling time are needed due to the radioactive decay time. A higher cooling time for maintenance in the area around the cone (interfase between LEBT and RFQ) should be assumed in future analyses. No data was available at the moment of these analyses.

To enter the HV cage, it is assumed that just a couple of seconds are required.

It has been considered that a spare accelerator column should be prepared, conditioned and ready for use.

b) Turn-on sequence

The turn-on sequence for the injector (taking into account that support systems are ready and safety systems like PPS allow the restarting of the operation) is composed as follows:

- 1st: Obtain nominal vacuum (3 hr)
- 2nd: Condition high-voltage gaps (8 hr)
- 3th: Gradually restart the beam to nominal intensity (4 hr)

This sequence is performed with the faraday cup intercepting the beam. It is possible to stay as long as needed in this position (with the beam ready to be sent) while waiting for other accelerator parts to be prepared. No personnel can be inside the vault if the beam is on.

If the vacuum is lost, then it will be necessary to begin from the first step when the system needs to be recovered. If the vacuum is not lost, only the third step is needed and the time is much less.

If there is a blackout for a few hours, then the system can be recovered from the third step. If the blackout is longer, however, then the recovery sequence must begin from the first step.

It is not necessary to stop the beam when maintenance is needed outside the vault; the beam is maintained with the faraday cup inserted and the valve closed (it will take only few seconds to recover).

For failures inside the vault but not in the injector, only a few minutes are needed to recover the injector system.

c) Design assumptions

- Vacuum system

No redundancies were foreseen for the reference design. It would be possible to install a redundant system for each pumping group. This has been considered as a possible improvement.

- Water-cooling system

Only the distribution water-cooling system was modeled.

- Instrumentation and MPS

The flow switch, temperature switch and other sensors are assumed to have a 2-out-of-3 voting configuration so that the whole accelerator will not be stopped by a single failure or spurious signal.

10.1.4 Probabilistic analysis and results

a) Reference design availability results

This design is quite robust; however, as nearly all components are located inside the vault, any small failure leads to quite a long MDT. Mean availability values together with upper and lower bounds obtained with RiskSpectrum are shown in Table 10.2.

	Mean	5%	95%
LEBT	99.94%	99.97%	99.88%
Source and extraction system	99.28%	99.87%	97.86%
Auxiliaries	97.81%	99.07%	95.96%
Local control system	99.98%	99.99%	99.93%
Injector	97.03%	98.62%	94.19%

Table 10.2 – Injector system reference design availability results

Auxiliaries are the main contributors to unavailability. In the next figure, availability results for each auxiliary part are shown.

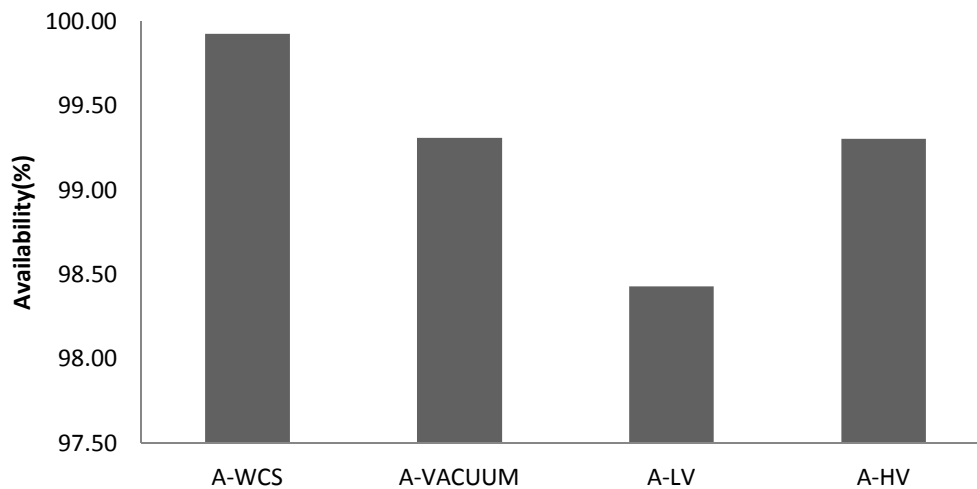

Figure 10.2 – Unavailability for each auxiliary subsystem. WCS means ‘Water-Cooling System’, Vacuum means the ‘Vacuum System’, LV the ‘Low-Voltage Power Supply’ and HV the ‘High-Voltage Power Supply’.

b) Events importance

The most problematic events are shown in the following table. The fraction contributor (FC) parameter determines the unavailability contributor of this event in the total unavailability. Events with higher FC are shown here.

Event	Code	FC
Power supplies in vault	1IVOSPSG001	$1.14 \cdot 10^{-01}$
Turbomolecular pump	1IVHVTPG001	$5.91 \cdot 10^{-02}$
Electrodes	1IVIBEEG001	$4.50 \cdot 10^{-02}$
Power supplies	1IGOSPSG001	$2.11 \cdot 10^{-02}$
HVPS	1IVOSVSG001	$1.56 \cdot 10^{-02}$
Step motor	1IVBISMG001	$1.36 \cdot 10^{-02}$
Magnetron	1IVRBMNG001	$1.15 \cdot 10^{-02}$
Power cables	1IVOSH4G001	$6.62 \cdot 10^{-03}$
Solenoids	1IVBSOG002	$5.35 \cdot 10^{-03}$
Coils	1IVBBCMG001	$4.27 \cdot 10^{-03}$

Table 10.3 – Importance of injector system reference design events

c) Sensitivity analysis

When analyzing the importance of the events and their parameters, it is also interesting to see how sensitive the results are to slight changes. In Figure 10.3, the tendency of the sensitivity-importance relationship is plotted in red. Moreover, the actual importance and sensitivity parameters of the injector components are also plotted.

As can be seen, the results follow the expected tendency. If the sensitivity of some components was considerably above the tendency line, that would mean that the importance of the component could be increased by slight changes in its parameters. This analysis shows that there is no clear evidence of components that could have more importance than expected if changes were made in their parameters.

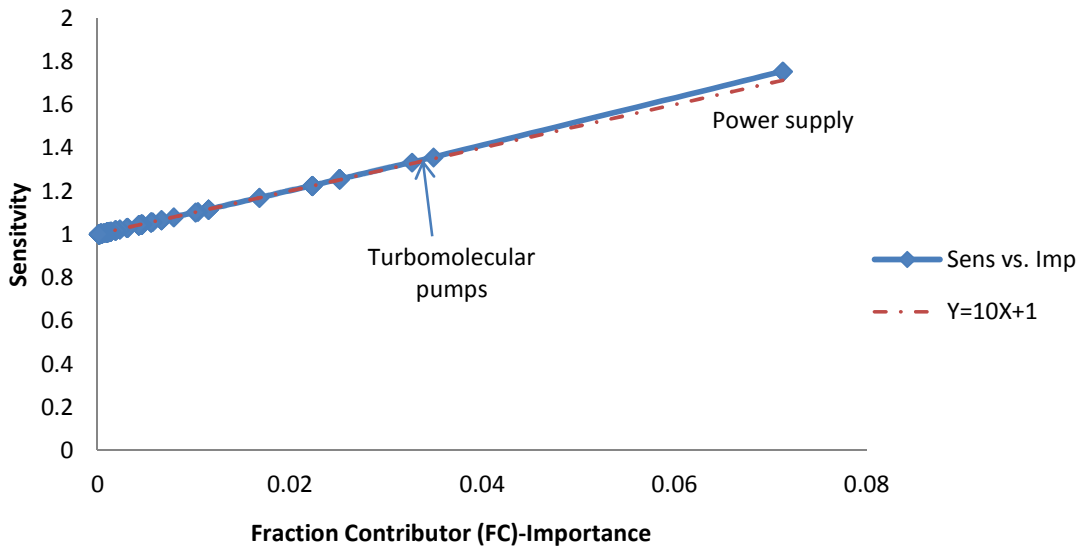

Figure 10.3 – Parameters' sensitivity versus importance

d) Possible design changes to improve availability

Power supplies in the vault (HV cage) appear to be the most problematic component as their access is not easy and their failure probability is not low. Several alternatives were proposed:

- Locate them outside the vault. This is too complicated due to high-voltage insulators and protections.
- Automatic power supply switch. It could be possible to have an automatic switch system to replace the failed components with spare ones as in ESRF [112].
- Permanent magnets. This would improve the compactness of the source, without a need for power supply or water cooling [111]. However, the lifetime of these components should be studied due to their demagnetization.
- Multilayer Coils. This is a type of coil configuration, proposed in the document [56], where each coil is independently powered and cooled. This option would create a complete redundancy, with two separate trains.

In the improved design analysis, an automatic switch has been assumed for the power supplies inside the vault except for the coils' PS. For the coils PS, the multilayer coil was chosen because it makes it possible to improve the availability of the coils themselves with all of their associated components.

Failure rate data obtained for the extraction electrodes did not correctly reflect the IFMIF injector design. An improvement was made in the electrodes' failure rate thanks to fabrication and design strategies (e.g., better isolation with less sparks and less probability

of failures). Preventive maintenance should be performed for such components in order to achieve acceptable reliability performances.

An important improvement could be accomplished in the vacuum system. Redundancy has been proposed for the two pumping groups, (2500 l/s and 150 l/s). Making the two pumping groups redundant involves a design change that may affect the disposition of other elements in the LEBT system.

e) Improved design availability results

The results of the model with the proposed design changes are as follows:

	Mean	5%	95%
LEBT	99.94%	99.97%	99.88%
Auxiliaries	99.04%	99.75%	97.40%
Source and extraction system	99.81%	99.93%	99.48%
Local control system	99.98%	99.99%	99.93%
Injector	98.76%	99.50%	97.31%

Table 10.4 – Injector system improved design availability results

Injector unavailability decreases considerably from 243 to 101 hours unavailable annually, which is nearly a 60% reduction.

10.1.5 Injector RAMI analysis conclusions

Injector availability results increase from 97.03% for the reference design model to 98.76% in the improved model. The availability requirement for this system is 98.90%. The result of the improved model does not meet this requirement but gets very close.

It is important to note that in previous analyses, when the requirements were proposed, the cooling time required to access the vault was estimated to be 12 instead of 24 hours. As the injector does not have a huge MDT but has several components with failure rates that are not depreciable, any change in the access time for maintenance in this system will decrease the availability considerably.

From the RAMI point of view, further availability improvements to this system could be very difficult to achieve.

10.2 Radio Frequency Quadrupole

The Radio Frequency Quadrupole (RFQ) system seems to be a very robust system from the RAMI point of view due to the passivity of its main components and to easy redundancies application in cooling and vacuum systems. If RAMI considerations are followed, acceptable availability performance seems achievable.

However, two major concerns appeared in the Detailed Design Document of the RFQ system [70] and in the last conversations with RFQ designers:

- RFQ modules wear out: in the last conversation with the designers on this issue, the answer was “an erosion of 0.2 nm/h in the first 4 modules is foreseen; we can run the machine more than 2500 hours,” which would not fit within the scheduled maintenance period. As this was just an estimation and no official confirmation was obtained, this was not included in the RAMI model. This information should be carefully analyzed and considered in future studies.
- RFQ cooling time: from the module activation calculations done in the RFQ DDD document [70] it was obtained that “hands-on operations ... are permitted after a few (≥ 3) cooling days ... after each short run operation ... Such a period has to be a few days longer (≥ 7) after a long test run.” As this was received after the model was already done, it was not possible to implement it. It should be better estimated and considered in future analyses.

10.2.1 Model description

The RFQ system is mainly modeled according to the PBS structure as shown in next figure.

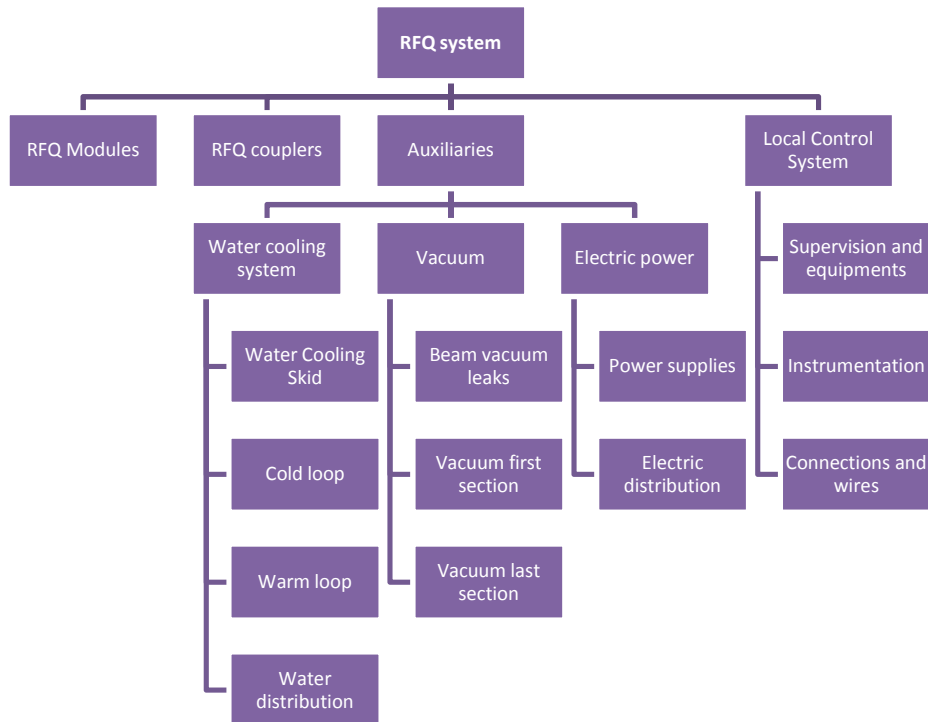

Figure 10.4 – RFQ model structure

10.2.2 Assumptions

Design assumptions considered for the RFQ reference design include all design changes proposed by the RAMI team. Therefore, no further improvements are proposed and there is no improved design model for this system.

a) *Water-cooling system*

All components of the WCS are located outside the vault, except for the pipes that connect the WCS to the RFQ structure.

WCS is divided into four main parts:

- Skid:

The components modeled and the minimum amount needed in order to operate is as follows:

Component	Qty.	Minimum to operate
Water pump	2	1
Heat exchanger	2	1
Water purification system	2	1
Valves (assumed normally open valves)	5	5
Reservation/Expansion tank	1	1
Pipes (1 meter)	5	5
3-way bypass control valve (by temperature sensor)	2	1
Skid electronics	1	1
Temperature sensors	4	2
Pressure sensors	4	2
Flow sensors	3	2

Table 10.5 – RFQ skid assumptions

It is proposed that a water pump, purification system, three-way bypass valve and heat exchanger to be redundant (and repairable online) be include, and that the skid will be able to operate even with some failures in their sensors.

- Warm circuits

There are three warm circuits in the system used to tune the RFQ cavities. The initial design included a 3-way valve upstream of the warm circuits to change the temperature of the circuits.

It is proposed to use redundant water pumps and redundant three-way valves. To do this, 4 manual valves would be needed for the pumps and 6 for the three-way bypass valve. On-line maintenance could be done for these components that are likely to be problematic.

Therefore, in the model performed, each circuit is composed by:

Component	Qty.	Minimum to operate
Water pump	2	1
Manual valves	8	4
Pipes (1 meter)	14	14
3-way bypass control valve (by temperature sensor)	2	1
Temperature sensors	4	2
Pressure sensors	4	2
Flow sensors	2	1

Table 10.6 – RFQ warm water cooling circuit assumptions

- Cold circuit

It is proposed to make the pump redundant.

Component	Qty.	Minimum to operate
Water pump	2	1
Manual valves	5	3
Pipes (1 meter)	14	14
Temperature sensors	4	2
Pressure sensors	4	2
Flow sensors	2	1

Table 10.7 – RFQ cold water cooling circuit assumptions

- Water distribution:

Cooling channels: Partial obstructions can be accepted. Total obstructions will lead to stopping the accelerator. Failure modes that lead to possible obstructions must be deleted as much as possible.

A total of 174 flow regulators were considered in the whole RFQ. The flow regulator is a passive component, but if it breaks, some part could be detached from the component and carried by the water flow. This piece of component could be very problematic if it lodges in the wrong place. If possible, a component without such risks should be used (like LEDA flow regulators) or appropriate filters should be included.

Connections and pipes: 292 flexible pipes with their connections were modeled.

b) Vacuum system

The vacuum system is composed of an ultra-high vacuum section and a low vacuum section. The system characteristics are:

- UHV section:
 - 10 cryopumps
 - Regeneration needed after 2,000 hours of beam operation
 - Between 3 and 6 hours will be needed to regenerate the cryo-pumps.
- Low vacuum section:
 - 3 fore-pumps
 - This system is needed during cryopumps' regeneration and after atmospheric pressure in the beam vacuum (e.g., commissioning, large maintenance)
 - If one fails, there is no direct consequence in accelerator availability.

- Redundancies considered

More cryopumps should be added into the design to ensure continuous operation (regeneration) and to allow some redundancies in case of failures. It is proposed to add 6 more cryopumps to the design.

Three fore-pumps were designed; a fourth redundant pump would increase the availability, thereby ensuring the cryopumps' regeneration and system recovery after a maintenance period.

To analyze the reliability of the cryopumps, two sections were considered. The first one was composed of the first 8 cryopumps and the second one was composed of the last 2. For each section, it was assumed that 8 and 2 cryopumps respectively are the minimum needed to operate. Any redundant pumps capable of replacing the failed pump function would increase the reliability of the section in which is added. The model is made as follows:

	LIPAc Design	Proposed reference design
First section	8 cryopumps, none redundant	12 cryopumps, 4 redundant
Last section	2 cryopumps, none redundant	4 cryopumps, 2 redundant

Table 10.8 – RFQ vacuum cryopumps assumptions

c) Instrumentation

Some failures in the gauges will be accepted; however, there should not be any implications for the availability. If one of the four points of measurement is not readable, the pressure profile will not be obtained, but there will be no impact on the beam.

d) Other RAMI-related issues

- RF vacuum window vacuum leak: It will be necessary to change the window and recover the vacuum. One day is required to change it and pump again (without taking into account the cooling and access time).
- RF vacuum window break: Open the RFQ, clean up and remove all possible pieces and change the window.
- Change a RFQ module: 1 or 2 days are required to change it (without considering cooling and recovery time).
- Arc detectors: Their signal alone will not make the accelerator stop; it must be combined with the reflected power.

10.2.3 Probabilistic analysis and results

a) Reference design availability results

	Mean	5%	95%
Modules	99.94%	99.99%	99.83%
Auxiliaries	99.39%	99.84%	98.46%
Control system	99.88%	99.97%	99.67%
Couplers	99.92%	99.99%	99.66%
RFQ	99.13%	99.68%	98.01%

Table 10.9 – RFQ reference design availability results

The major unavailability contributors are the auxiliaries. Even after several redundancies, this is the most problematic subsystem. As the requirements are achieved with the reference design model, no further improvements are proposed and no analyses are done for an improved design model.

b) Importance of parameters and events

Event	Code	FC
Cryopumps section 1	1RVFVCRG014	$1.10 \cdot 10^{-02}$
Cryopumps section 2	1RVFVCRG003	$1.03 \cdot 10^{-02}$
RF vacuum window	1RVFRRWR002	$9.83 \cdot 10^{-03}$
Cooling channels	1RVRCGG002	$8.16 \cdot 10^{-03}$
Power supply	1RGOSPSG015	$5.03 \cdot 10^{-03}$

Table 10.10 – RFQ reference design availability results

Even with redundancies, the cryopumps appear to be the major unavailability contributors. Higher-capacity pumps could be added in order to accept some a higher amount of failures.

The RF vacuum window is a component that requires special attention due to its probability of breaking and polluting the RFQ cavity.

10.2.4 RFQ RAMI analysis conclusions

The result of the reference design with the assumed easily applicable design changes (99.13%) meets the availability requirements (98.60%). This result is much better than the one obtained with the old reference design (98.19%), which was the one used to determine the requirements in previous analyses [77].

However, future analyses must consider module replacement due to wear-out and additional cooling time for hands-on maintenance. Seven days of cooling time can greatly increase the unavailability of this system. The wear-out of modules can imply serious changes in maintenance and operation strategies and can become a huge unavailability contributor.

10.3 MEBT

The MEBT reference model design includes some possible improvements that may increase its hardware availability. Moreover, some failures can be accepted along with their consequent beam degradation. In case of this acceptance, the beam would need to highly reduce its nominal parameters due to the beam focusing functions of MEBT components. MEBT failures usually lead to stopping the accelerator or reducing its beam parameters.

The scrapers' cooling time and shielding are the main problems encountered in the maintenance activities to be performed in this system. Cooling time parameters for hands-on maintenance should be studied in more depth.

10.3.1 Model description

The model used for the MEBT follows the structure shown in Figure 10.5.

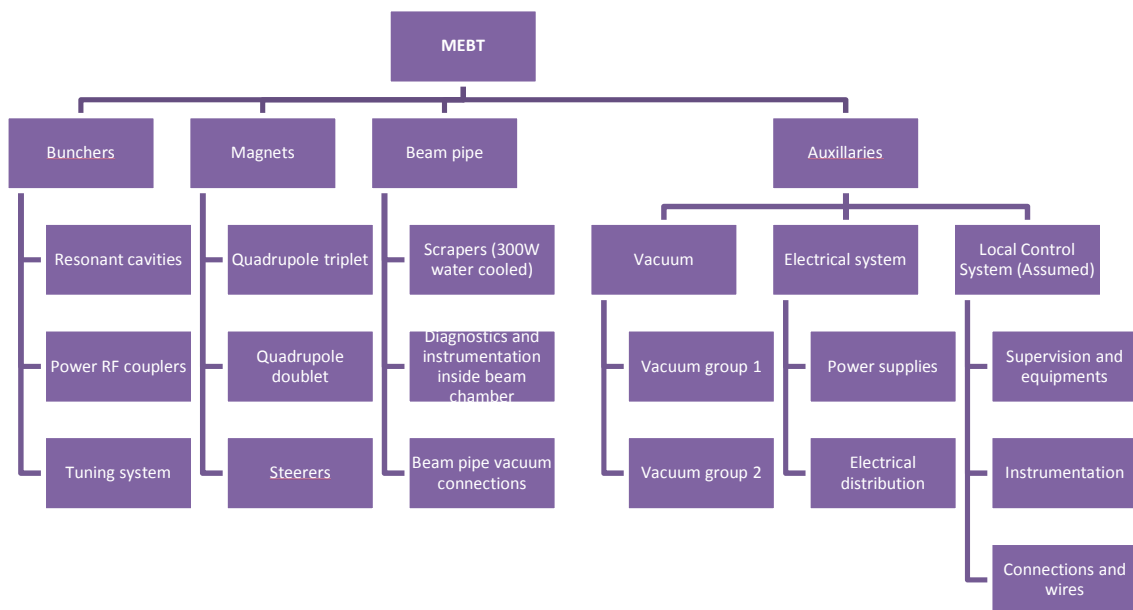

Figure 10.5 – MEBT model structure

10.3.2 Assumptions

a) Failure acceptance assumptions

- Quadrupole failure

If there is a failure in one of the quadrupoles, it is assumed that the operation could continue as long as the beam intensity is reduced to 70% and the accelerator is adequately re-tuned. To do so, the polarity of the quadrupoles may need to be changed.

- Bunchers

Both bunchers are considered to be essential in order to be able to operate the accelerator.

- Steerers

One failure per plane of the four steerers is assumed to be acceptable if the intensity is reduced to 115 mA.

Component and kind of failure	Number of failures	Maximum intensity	Energy reduction	Beam shape degradation
Quadrupole	One	87.5 mA	No	No
Steerer	One per plane	115 mA	No	No

Table 10.11 – MEBT failure acceptance

b) Vacuum system

For the reference design analysis, a redundant design is assumed. Two groups of two redundant vacuum pumps are considered.

c) Other assumptions

MEBT scrapers need a dedicated shielding to decrease the radiation in the vault. Such shielding increases the time required to perform maintenance (cooling and dismounting) for the components inside it. The time required for hands-on maintenance in components near the scrapers was assumed to be one week.

10.3.3 Probabilistic analysis and results

a) Reference design availability results

The reference design results for the MEBT are shown in the following table:

	Mean	5%	95%
Bunchers	99.81%	99.95%	99.54%
Auxiliaries	99.55%	99.93%	98.62%
Control	99.93%	99.99%	99.79%
Beam line	99.50%	99.88%	98.58%
Magnets	99.84%	99.96%	99.54%
MEBT	98.62%	99.42%	97.19%

Table 10.12 – MEBT reference design availability results

The main contributors to unavailability are the auxiliaries and the beam line components.

b) Importance of parameters and events

Event	Code	FC
Turbomolecular pump	AHBOVTPG003	$8.12 \cdot 10^{-02}$
RF window (break)	1MVVRRWL001	$3.46 \cdot 10^{-02}$
Step motor (no response)	1MVRBSMN001	$2.30 \cdot 10^{-02}$
Feedthroughs (leak)	1MSVVEFL010	$1.25 \cdot 10^{-02}$

Table 10.13 – MEBT events importance

Vacuum pumps appear to be major unavailability contributors, even with the proposed redundancies. A RF window rupture can be problematic due to its pollution consequences. Better reliability should be pursued further. A lack of response from the step motor could lead to the inability to tune the bunchers. This is a probable event that should be prevented as much as possible.

c) Possible design changes to improve availability

It is proposed to have a design with redundant step motors for the buncher tuning system. In the improved design model, such redundancy is modeled, allowing tuning with the redundant step motor when the other fails to respond.

The MEBT scrapers could require long cooling time periods to allow hands-on maintenance. It could be difficult to extract the shielding to perform maintenance on the components inside. It is proposed to have a big module that includes the shielding and all the components (e.g., quadrupoles, steerers, scrapers) that could be easily extracted from the beam line and replaced with a spare. This would greatly decrease the MDT of failures in this section. This design change would require an accessible way to disconnect the MEBT from the RFQ, which is not currently possible.

As seen in other systems (e.g., ESRF [112]), it could be possible to have an automatic switch system that replaces the failed power supply components with spare ones. The mean time to restart the operation after a failure could be less than 20 minutes. Even if it is not a very important parameter for the MEBT, it could seem logical to reduce their implication in the unavailability following the strategy of other systems (as will be seen in the analyses of other systems).

d) Improved design results

	Mean	5%	95%
Auxiliaries	99.61%	99.94%	98.77%
Beam line	99.77%	99.94%	99.28%
Bunchers	99.87%	99.98%	99.58%
Control	99.93%	99.99%	99.79%
Magnets	99.91%	99.97%	99.76%
MEBT	99.08%	99.64%	98.00%

Table 10.14 – MEBT's improved design hardware availability results

Hardware availability does not quite reach the required level of 99.50%, but it increases its value from 99.62% to 99.08%. This represents a reduction of about 40% of the unavailable time for this system.

10.3.4 MEBT RAMI analysis conclusions

An easy way to disconnect MEBT from RFQ should be pursued in order to allow faster maintenance performance.

Cooling time for scrapers and their surrounding components and shielding is very important to perform a realistic availability calculation. Future analyses should take into account any change in these parameters.

10.4 SRF linac

SRF linac is a complex system with large MDT parameters because of the long periods required for maintenance in cryogenic components. This system is very important from the RAMI point of view due to the risk of having long shutdowns caused by it.

Failure acceptance and beam degradation are of the utmost importance for this system due to its possible huge MDT. Previous analyses showed bad availability results if such acceptances are not be possible. A great effort was done to find possible failures acceptance and their consequences in the beam. The major number of failure acceptances explained in Chapter 8 corresponds to this system.

In order to compare the results obtained with the SRF linac reliability models, a comparison was done in Chapter 9.4, where operational experience was gathered and extrapolated to the case of the IFMIF.

10.4.1 Model description

The model follows not only the PBS structure but a functions structure as well. It follows the degraded operation modes and their implications for the beam parameters described in the failure acceptance and beam degradation in the next subchapter. The model structure is as follow:

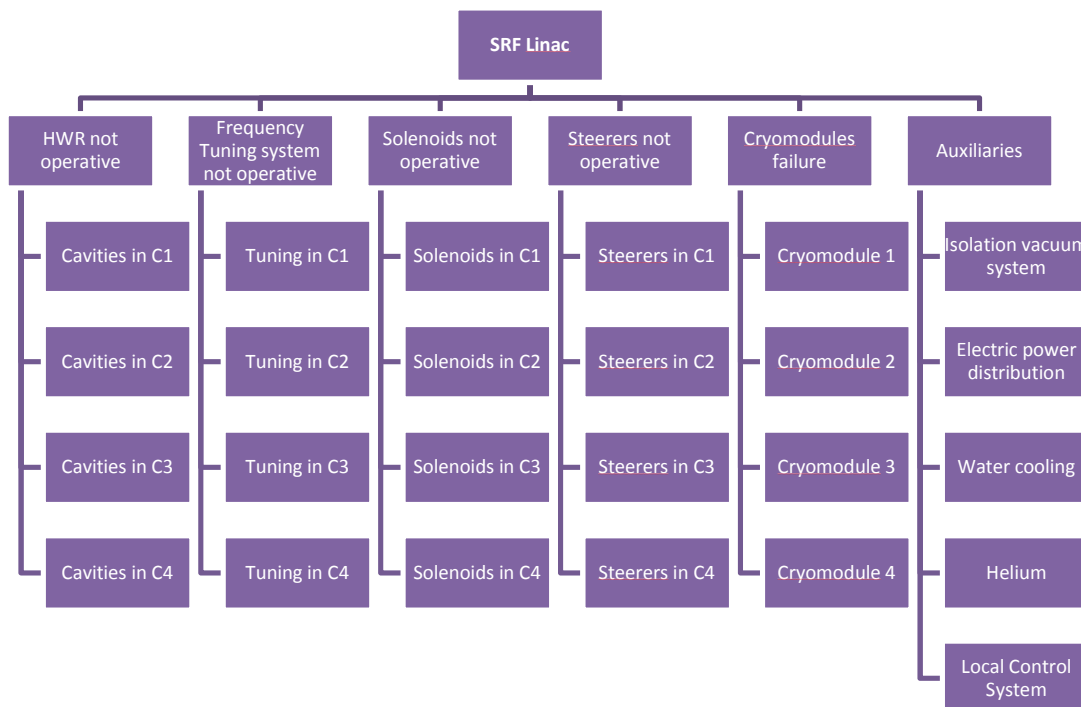

Figure 10.6 – SRF linac model structure

10.4.2 Assumptions

a) Generic assumptions

The model does not take into account the changes in the cavity tuning system design proposed in [74]. The model follows the plunger-based design shown in SRF linac Detailed Design Document [68] for the four cryomodules.

Maintenance of components that require loss of the isolation vacuum and warming up of the cryomodule but not to bring the cryomodule to a clean room (e.g., cavity tuning system) can be done in the 20 days of the long scheduled maintenance period.

It is assumed that the cryomodule transfer time to a clean room is not huge due to the proximity and availability of such room. If this is not the case, the impact on the availability should be studied.

b) Design assumptions

- Isolation vacuum system

A redundant isolation vacuum system is considered for each cryomodule. It is assumed that such a system would make it possible to accept some small leaks in the cryomodule isolation vacuum.

- Beam vacuum system

A beam vacuum system is not modeled because it will be operative only in maintenance periods and not during normal accelerator operation.

- Magnets power supplies

For the reference design, it is assumed that an easy corrective maintenance action is possible for components such as easily switchable modular boards or easily connectable spare modules. The mean time to replace the failed component and restart the beam is estimated to be about 2 hours.

c) Failure acceptance and beam degradation

As explained in Chapter 8, the failure of several SRF linac components will degrade the beam (with an adequate tuning) but not fully stop the accelerator. In the reference design of the SRF linac, these degraded operation cases were accepted as correct system performance. Beam degradation of the accepted failures is accounted for in the beam effectiveness parameter.

As failure acceptance and beam degradation cannot be implemented in RiskSpectrum, some assumptions are made to take such degradations into consideration. It is assumed that it could be possible to continue operation with 2 non-operative cavities and 4 failed cavity tuning systems. Moreover, in the accelerator, one solenoid failure and three failed steerers per plane are also accepted. It is assumed that if any of these conditions were to be exceeded, then the accelerator would stop operation and maintenance actions would be performed.

Furthermore, some small isolation vacuum leaks could be acceptable. Vacuum pumping groups have more capacity than that which is nominally required. Therefore, several leaks could be acceptable, and it is assumed that they would be repaired in the following cryomodule maintenance without affecting the availability. In this case, it is very important to know the frequency of maintenance in the cryomodules and the leak acceptance of the isolation vacuum system. At SNS, several leaks have occurred in cryomodules, but no cryomodule refurbishment was needed: “there are seven cryomodules with known insulating vacuum leaks and have additional turbo pumps installed on them in the tunnel” [102]. In the model, two small leaks in each cryomodule isolation vacuum are acceptable.

d) Reliability assumptions

The SRF linac availability results obtained in previous analyses showed that the reliability data used for the components inside the cryomodule may be too pessimistic. For this analysis, the reliability of such components is assumed to be of fine quality with appropriate quality tests. As no specific reliability data for fine quality components have been found in reliability databases, normal components failure rates were taken and improved as follows:

Component	Original FR (h ⁻¹)	Improved FR (h ⁻¹)	Improvement factor
Step motor (no response)	1.25·10 ⁻⁵	1.25·10 ⁻⁶	/10
Flexible membrane (leak)	2·10 ⁻⁶	1·10 ⁻⁷	/20
Flange and gaskets (leak)	1·10 ⁻⁸	5·10 ⁻⁹	/2
RF vacuum window (leak)	1.22·10 ⁻⁵	1.22·10 ⁻⁷	/100
Welds (leak)	2.4·10 ⁻⁸	4.8·10 ⁻⁹	/5
Bellows (leak)	8·10 ⁻⁸	1.6·10 ⁻⁸	/5
Electrical feedthrough (leak)	1·10 ⁻⁶	6.67·10 ⁻⁸	/15
Beam vacuum valve (control)	3·10 ⁻⁶	6·10 ⁻⁷	/5
Beam vacuum valve (leak)	1·10 ⁻⁷	5·10 ⁻⁸	/2
Plunger (Leak)	9.8·10 ⁻⁸	1.96·10 ⁻⁸	/5
Vacuum connection (leak)	1.45·10 ⁻⁸	2.9·10 ⁻⁹	/5
Liquid Helium welds (leak)	1.43·10 ⁻⁸	2.86·10 ⁻⁹	/5
Helium pipes connection (leak)	1·10 ⁻⁸	2·10 ⁻⁹	/5
Access traps and doors	3.4·10 ⁻⁶	3.4·10 ⁻⁷	/10

Table 10.15 – SRF linac reliability parameter improvements

In the bellows case, a double-bellow design could be studied to increase its reliability [113].

- *RF window reliability:*

These components were found to be very problematic in previous RAMI iterations. This is why a specific search for failure rate data was done.

A failure rate of $1.22 \cdot 10^{-5} \text{ h}^{-1}$ was found in [114]. In [115], a deep study on RF windows of the KEKB linac accelerator was done. The operational statistical data obtained showed that the lifetime of their RF windows was about 14,000 hr and the MTBF was about 150,000 hr, which means a failure rate of $6.6 \cdot 10^{-6} \text{ h}^{-1}$.

From an SLAC document [49], a failure rate of klystrons RF windows of $7.7 \cdot 10^{-6} \text{ h}^{-1}$ was obtained. In the document “Arcing Phenomena on CEBAF RF-Windows at Cryogenic Temperatures” [99], a study of the causes of arcs in the RF windows was conducted taking into account different designs and fields. This may be an interesting way to reduce the number of trips and increase the RF windows’ lifetime and MTBF. Tests were done for the accelerator production of tritium [116], and many problems and failures occurred. The data obtained from those tests could be helpful for the IFMIF designers.

An improved failure rate was considered for the IFMIF SRF linac system model; however, if such a reliability value cannot be achieved, then a redundant design could be proposed.

A RF windows sensitivity analysis is performed in next subchapter.

10.4.3 Probabilistic analysis and results

a) Reference design availability results

Considering the reference design and the assumptions explained in this document, the annual hardware availability results for SRF linac system are as follows:

	Mean	5%	95%
Auxiliaries	99.51%	99.85%	98.78%
Cryomodule 1	99.35%	99.75%	98.16%
Cryomodule 2	99.28%	99.69%	97.83%
Cryomodule 3	99.19%	99.67%	97.68%
Cryomodule 4	99.19%	99.68%	97.47%
HWRs	99.95%	99.99%	99.85%
Isolation vacuum leaks	100.00%	100.00%	100.00%
LCS	99.83%	99.96%	99.54%
Beam vacuum leaks	99.85%	99.99%	99.43%
Solenoids	100.00%	100.00%	99.98%
Steerers	100.00%	100.00%	100.00%
Cavities tuning	99.76%	99.96%	99.37%
SRF LINAC	96.12%	98.00%	91.08%

Table 10.16 – SRF linac hardware availability results

Failures which repair require large maintenance periods that occurred during operation are considered in the results; however, as these results were obtained through an annual availability analysis, it was not considered whether the long maintenance period (20 days) should be enlarged if there is a failure that requires the refurbishment of a cryomodule (2.5 months). When considering this issue, the result of the SFR linac drops to 93.15%.

An analysis of those refurbishments is done in the following subsection.

b) Reliability analysis: Cryomodule refurbishments

Refurbishments due to beam vacuum leaks and other fatal failures during normal operation have been calculated. The mean values are as follows:

	Annual number of failures	Refurbishments in 30 years	Operational years to have a failure
Components failures	0.178	5.349	5.609
Leaks	0.005	0.129	0.132
TOTAL	0.183	5.478	5.477

Table 10.17 – Number of cryomodule refurbishments depending on leaks or component failures

In this analysis, it has been assumed that it is possible to operate with some failures in the components of the SRF linac. Therefore, a limit is placed on maintenance to a

cryomodule when the beam degradation is too important to continue operation (as defined in Chapter 8) or when there is a long maintenance period and a failed component degrades the beam to any extent.

Isolation vacuum leaks have been calculated. Results show that if a proper isolation vacuum system is designed to allow few small leaks, then this kind of failure could be neglected. The results seem similar to the experiences of other facilities: "The frequency of occurrence of small leaks is reasonably low; it constitutes a nuisance but as yet no more than a slight headache" [117].

The number of refurbishments expected to be done in scheduled maintenance periods are as follows:

	Failures to be repaired in each scheduled maintenance	Refurbishments in 30 years	Operational years to have a failure	Probability of reaching the maintenance period with a failure in one of the cryomodules
HWR	0.118	3.535	8.486	11.78%
Solenoid	0.031	0.940	31.912	3.13%
Steerers	0.029	0.874	34.341	2.91%
TOTAL	0.178	5.349	5.609	17.83%

Table 10.18 – Number of refurbishments due to component failures in maintenance periods

Total refurbishments:

	Annual number of failures	Refurbishments in 30 years	Operational years to have a failure
During operation	0.183	5.478	5.477
In maintenance period	0.178	5.349	5.609
TOTAL	0.361	10.827	2.771

Table 10.19 – Cryomodule refurbishments in operation or maintenance periods

As was mentioned in the comparative analysis done in Chapter 9, about 7 refurbishments should be expected for each accelerator over the course of the IFMIF's lifetime. On the other hand, the expected number of refurbishments calculated in this probabilistic analysis is about 10.8 refurbishments. Therefore, the calculated number of refurbishments seems to be coherent with operational data from other facilities.

c) Time dependency analysis

Since there are high MDT parameters, unavailability stabilization over the annual time could be important. As can be seen in Figure 10.7, the unavailability stabilizes in one year. Therefore, it has no relevance to the availability results obtained.

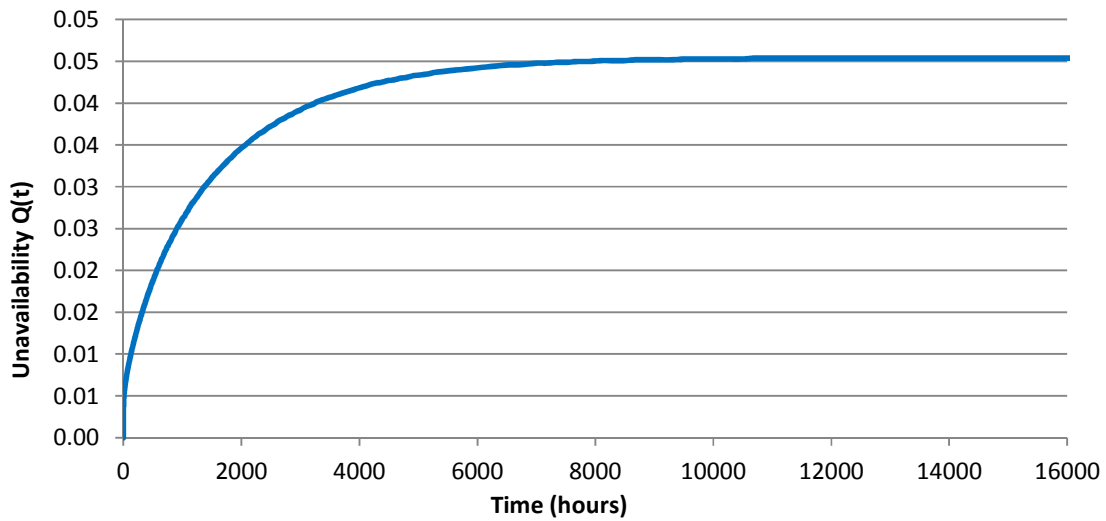

Figure 10.7 – SRF unavailability stabilization

d) Importance of Events

Event	Code	FC
Vacuum window leak	1SVYRRWZ022	$4.62 \cdot 10^{-03}$
Vacuum valve leak	1SVCVVTX010	$4.58 \cdot 10^{-03}$
Flexible membrane leak	1SVYBFBZ031	$3.77 \cdot 10^{-03}$
Feedthrough leak	1SVYBEFZ032	$2.52 \cdot 10^{-03}$
Vacuum weld	1SVYBWSL047	$9.09 \cdot 10^{-04}$
Power supply	1SGNSPSG051	$7.68 \cdot 10^{-04}$
Plunger	1SVYBPRZ038	$7.40 \cdot 10^{-04}$
Bellow	1SVYVBEZ027	$6.05 \cdot 10^{-04}$

Table 10.20 – SRF linac events contribution to unavailability

Vacuum leaks appear as the major unavailability contributors even after important improvements in their reliability parameters were done. Power supplies also appear to be problematic components.

e) Sensibility analysis

- RF window reliability

As seen in the event importance analysis, the vacuum window is still the most important unavailability contributor. A specific analysis was performed for this component, a design with an additional and redundant window was proposed.

From an SLAC document [49], a design with two RF windows is presented to decrease the number of stops due to RF windows failures.

From [118], the idea of the two windows is also explained: “Very high power klystrons commonly have two windows in parallel to handle the full output power. Windows can be destroyed by excessive reflected power, by arcs in the output waveguide, by X-ray bombardment, and by the multipactor discharges. The basic cause of failure is overheating and it is usual to monitor the window temperature and to provide reverse power and waveguide and cavity arc detectors.”

In [44], a design with two RF windows in the XFEL accelerator coupler is described: “The elaborate two-window solution was chosen for additional protection of the cavity against contamination during mounting in the accelerator module, and against a window fracture during linac operation.”

Based on the information found, several failure rates were analyzed and the two RF window alternative was studied. The results are shown in the following figure. This figure shows the reliability of the 42 RF windows of the SRF linac over 3 years.

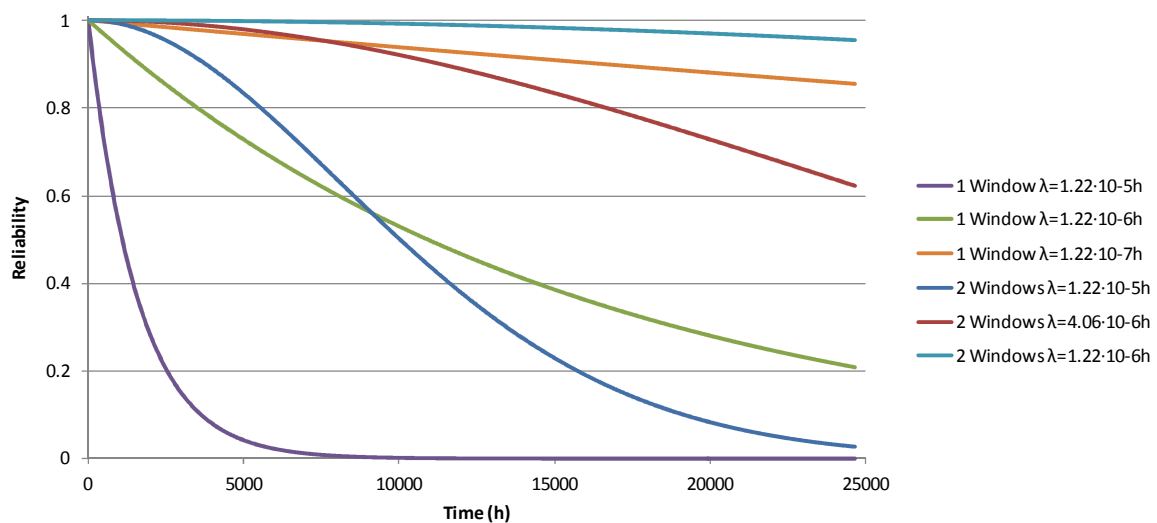

Figure 10.8 – RF window reliability

The probability of stopping due to a problem with a ceramic window is very high if the failure rate used is the one found in the literature. If the value is around 100 times better, then the reliability could be acceptable (1.25 failures over 30 years of operation). Nevertheless, if the failure rate were 10 times better and two ceramic windows were installed, then the probability of a failure before a dedicated maintenance plan (considering a maintenance plan for cryo-components of 3 years) would be 0.15 failures every 30 years of operation.

Redundancy in ceramic windows could be a good option to achieve better availability performance if its failure rate is not better than $1 \cdot 10^{-6} \text{ h}^{-1}$.

- Cavities tuning system reliability

The cavity tuning system is composed of mechanical components inside the cryomodule. Failures are probable (IFMIF MTBF = 800,000 hours, SLAC MTBF = 500,000 hours, TTF MTBF less than 500,000 hours). The MDT is not huge (about 15 days), so it is possible to make this repair during the long maintenance shutdown; however, it is important to reach the scheduled maintenance period without too many failures.

The failure rate for each tuning system is composed by 4 electrical connections ($5 \cdot 10^{-7} \text{ h}^{-1}$ each), 1 screw ($1 \cdot 10^{-8} \text{ h}^{-1}$), 1 step motor ($1.25 \cdot 10^{-6} \text{ h}^{-1}$) and 4 wires ($7 \cdot 10^{-7} \text{ h}^{-1}$ each). The total is $6.06 \cdot 10^{-6} \text{ h}^{-1}$.

Reliability for an accepted degraded operation with one or two failed tuning systems over 5 years is as follows:

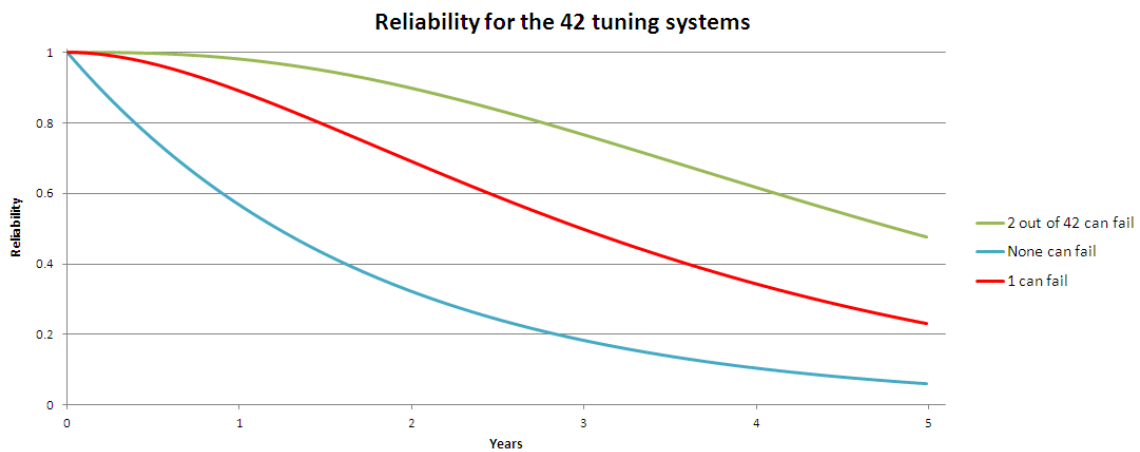

Figure 10.9 – Tuning system reliability

If no failures can be accepted, then the probability of achieving more than 3 years without a failure is very low. Redundancy in step motors would increase reliability.

This corresponds also with what has been found in [52] “The cold design calls for the cavity tuner stepping motors to be inside the cryostat. Using a nominal MTBF of 500,000 hours (taken from SLAC mover experience) resulted in so many tuner failures that a multi-month access was needed to perform repairs. To keep this from skewing the results, 1 million hours was used. It will become evident later that it will be necessary to make these components redundant or to bring them outside the cryostat.”

It seems that continuous operation requires failure acceptance; however, as the beam will be degraded for each accepted failure, cavity tuning system reliability should be increased.

f) Possible improvements to increase availability

Both probabilistic analyses and comparisons with other SRF linacs show that several cryomodules refurbishments (a mean value of between 7 and 10 times over 30 years) will be performed for each accelerator. As has been seen in Chapter 9, several accelerators had cryomodule spares or will require them eventually. For this improved design analysis, it is assumed that three hot spare cryomodules will be available (one for each kind of cryomodule, assuming that the cryomodule 3 and 4 are identical). The time required to exchange a failed cryomodule with a spare one was estimated to be 20 days, which would fit within the long scheduled maintenance and would reduce the MDT in the case of fatal failure during operation.

Moreover, it could be possible to include an automatic switch system that replaces failed PS with spare ones as in ESRF [112]. The mean time to restart the operation after a failure could be less than 20 minutes.

g) Results for different SRF linac models

Different cases are proposed to demonstrate the importance of hot spare cryomodules together with failure acceptance. The importance of using hot spare cryomodules and accepting beam degradation can be seen in Table 10.21.

Case	Characteristics	SRF linac hardware availability
Case 1	- Without hot spare cryomodules - Accepting beam degradation	93.15%
Case 2	- With hot spare cryomodules - Accepting beam degradation	98.07%
Case 3	- With hot spare cryomodules - Not accepting beam degradation	88.20%
Case 4	- Without hot spare cryomodules - Not accepting beam degradation	81.80%

Table 10.21 – SRF linac hardware availability for different design and acceptance cases

For case 1, the annual availability model result obtained was 96.12%; however, the time spent in extend the scheduled maintenance to perform cryomodule refurbishment (once every 4 years approximately) has been added.

Since the improved design is assumed to have hot spare cryomodules and beam degradation will be accepted, the results of case 2 were chosen for the improved design model.

10.4.4 SFR linac RAMI analysis conclusions

The SRF linac system needs to ensure that components inside cryomodules have sufficient quality to achieve low failure rates. Fault-tolerant designs should be pursued, adding redundancies and accepting operation with a degraded beam. Redundant step motors, two redundant vacuum windows and the possibility of operating with some failed cavities should be pursued.

The option of hot spare cryomodules should be carefully analyzed due to the increase of cost; however, spares will be required for logistic reasons (e.g., time to manufacture principal components is between 6 months to one year) and it does not seem excessive to have them mounted in the cryomodules and prepared for operation.

In this analysis, it is assumed that the cryomodules will be in continuous operation over the 30 years of operation. No scheduled maintenance periods are foreseen for cryogenic components at this moment; however, many other cryogenic accelerators have specific maintenance plans. Information about this issue could be gathered and analyzed in future studies. A specific maintenance plan should be defined and its influence in the availability calculated.

As explained in Chapter 9, one optimization could be to have a few types of smaller cryomodules on the beam line in order to have only few spares cryomodules. This design would improve the maintainability thanks to an easier cryomodule refurbishment and could reduce substantially the logistics and cost of the spare cryomodules. This option would require a complete re-design of the SRF linac. This proposal should be analyzed in the future.

10.5 HEBT

HEBT is distributed among the vault, the BTR and the RIR rooms. The access time to these rooms plays a very important role in determining its availability. Assumptions about such access time should be revised in future analyses. The cooling times of scrapers and collimators for hands-on maintenance have also been estimated.

10.5.1 Model description

The HEBT model follows the PBS structure, as can be seen the figure below.

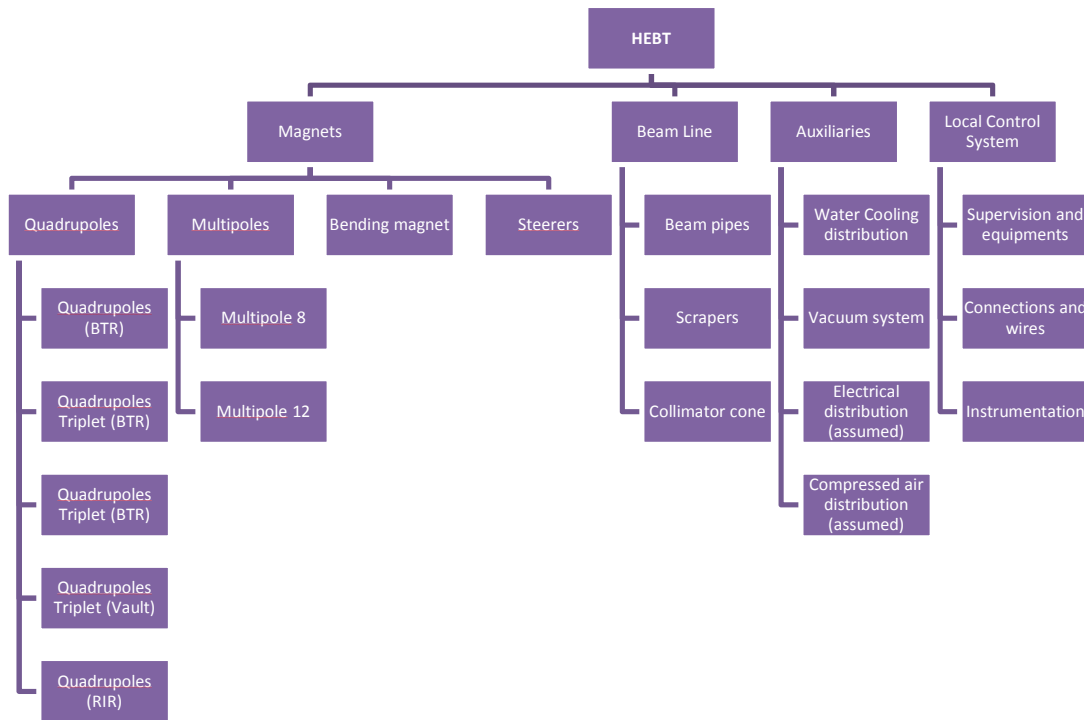

Figure 10.10 – HEBT model structure

10.5.2 Assumptions

a) *Beam degradation assumptions*

Several beam degradations have been assumed in the HEBT. Failures in triplets' quadrupoles could be accepted if beam intensity is decreased and proper tuning is performed. Some focusing magnets are required to achieve a good beam focus in the beam pipe and cannot fail; however, others are needed to obtain a good beam shape and could fail without many beam implications. Such assumption should be verified by simulating the produced beam shape and confirming that it could be valid for the target and test facilities.

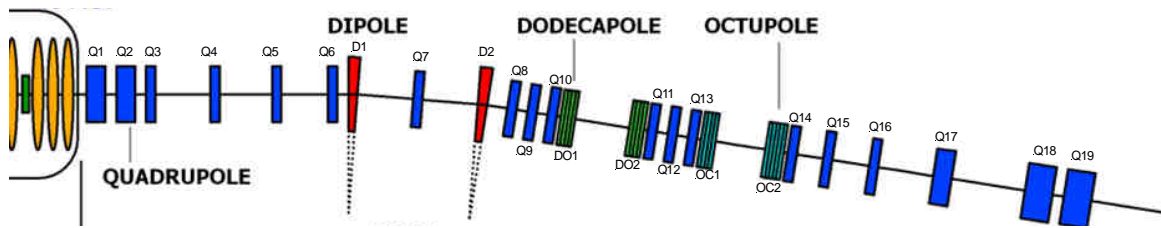

Figure 10.11 – HEBT magnets configuration

Quadrupoles' accepted failures and beam degradation:

Components	Location	Acceptance	Consequence	Comments
Triplet (Q1, Q2 and Q3)	Vault	One failure acceptable	Intensity decrease	
Triplet (Q4, Q5 and Q6)	BTR	One failure acceptable	Intensity decrease	
Triplet (Q8, Q9 and Q10)	BTR	One failure acceptable	Intensity decrease	Scraper and shielding
Triplet (Q11, Q12 and Q13)	BTR	One failure acceptable	Intensity decrease	Scraper and shielding
Q7 or Q14 or Q15 or Q16 or Q17	BTR	No failures acceptable	Beam stop	
Q18 or Q19	RIR	No failures acceptable	Beam stop	Possible accepted failure but bad beam shape

Table 10.22 – HEBT quadrupoles' location, accepted failures and consequences

b) Beam Turn-on:

- First, the beam is sent to the beam dump in a duty cycle mode. When the accelerator is ready and delivering the correct beam, and when the Li-target is ready for the beam, the beam is switched to the lithium target. Then, the pulse is extended until CW is reached.
- Taking into account the accelerator steps (Chapter 8), this switch would be performed in step 6.

c) Operation and performance assumptions:

- The diagnostic plate will only be used in commissioning.
- In the vault, there is only a triplet.
- TIR diagnostics lifetime is unknown due to lithium and radiation environment.
- It is assumed that components inside the TIR will need RH. For the RIR, the intention is to be hands-on.

- Possible standardization of magnets is considered in order to have less spares, with one spare for each group (3 groups in total). Several days for changing magnets + cooling time = about 1 week in total.
- It is planned to have 1 BPM for each quadrupole. It is possible to operate with some of them having failed.

d) Design assumptions

- Vacuum system

The vacuum system is assumed to be composed by 10 groups of 2 vacuum pumps (each composed by a titanium sublimation pump and an ion pump).

Location	Number of groups	Pumps per group	Minimum to operate
Vault	1	4	2
BTR	6	2	1
RIR	1	4	2

Table 10.23 – HEBT vacuum system redundancy

Vacuum pumps located near the SRF linac are very important to keep a good vacuum level. More redundancies are considered for pumps located in the RIR because access time to this room will be higher.

10.5.3 Probabilistic analysis and results

a) Reference design availability results

	Mean	5%	95%
Magnets	99.77%	99.95%	99.38%
Beam line	99.67%	99.95%	99.00%
Auxiliaries	99.71%	99.96%	99.18%
Control system	99.98%	100.00%	99.94%
HEBT	99.13%	99.72%	97.99%

Table 10.24 – HEBT reference design hardware availability results

b) Importance of parameters and events

The following events are those that contribute more to unavailability:

Component	Code	FC
Step motor (Scraper insert)	1HSVBSMP003	$2.48 \cdot 10^{-02}$
Beam pipe valves	1HBBVVOP001	$2.26 \cdot 10^{-02}$
Magnet power supply	1HGOSSPG016	$5.63 \cdot 10^{-03}$

Table 10.25 – Importance of HEBT reference design events

In addition to step motors, other components in or near the scrapers have been identified as problematic due to the large access time that they require for hands-on maintenance.

Magnets’ power supplies have a big influence on availability. As there are several identical components, any improvement in their parameters will noticeably increase the availability.

c) Possible design changes to improve availability

As explained in the MEBT, scrapers and their surrounding components could require large cooling time periods to allow hands-on maintenance. Moreover, it could be difficult to extract the shielding to perform maintenance for components inside it. Therefore, it is proposed to have a big module that includes the shielding and all of the components inside it (e.g., quadrupoles, steerers, scrapers) that could easily be extracted from the beam line and replaced with a spare. This would greatly decrease the MDT of failures in these sections. This design change for the two triplets (Q8, Q9, Q10 and Q11, Q12, Q13) has been assumed for the HEBT improved design.

As magnets’ power supplies have a big impact on the availability, a design similar to the one done in ESRF [112], in which a switching board connects a redundant power supply in case of a failure, could be performed to improve the availability. The assumed time to restart operation after a failure is about 20 minutes.

d) Improved design results

	Mean	5%	95%
Auxiliaries	99.81%	99.97%	99.38%
Beam line	99.67%	99.95%	99.05%
Local control	99.98%	100.00%	99.94%
Magnets	99.77%	99.96%	99.30%
HEBT	99.23%	99.75%	98.16%

Table 10.26 – HEBT improved design hardware availability results

Reference design HEBT availability results were very good; however, some improvement has been achieved by implementing the recommendations. Specifically, the mean annual unavailable time was decreased by 11.5%. The improved design achieves the availability requirement imposed on the HEBT of 99.20%.

10.5.4 HEBT RAMI analysis conclusions

Hardware availability performance is very good considering that some failures that degrade the beam are accepted. Such failures decrease the beam effectiveness and, consequently, beam availability. Although these cases do not occur very often, they must be considered in the results.

10.6 Diagnostics

The diagnostics are physically inside other accelerator systems, but since they follow a common goal they are grouped and analyzed together here.

There are different kinds of diagnostics. The interceptive ones are not used during operation, which is why they are not considered in the evaluation of the availability. The non-interceptive diagnostics have two different goals: they assist in beam characterization or they are essential to allow the operation. Those used for characterization are not needed during operation, so they are not important for this analysis. The diagnostics analyzed in these studies are the essential ones; however, the diagnostics required to allow beam tuning after a shutdown should be considered in future analyses.

The following chart shows the diagnostics classification used for the RAMI analyses:

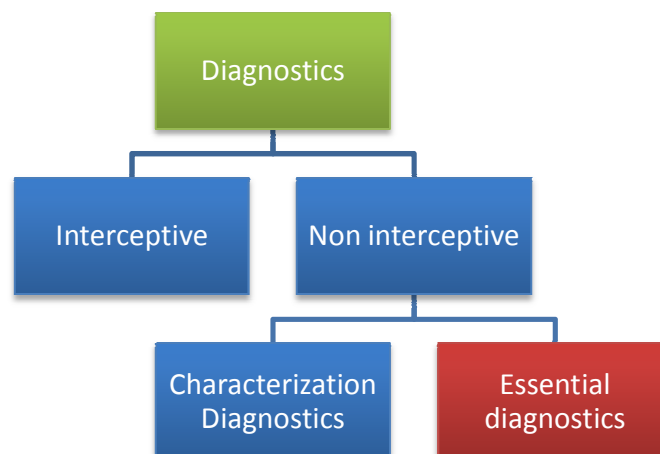

Figure 10.12 – Diagnostics classification

The most interesting diagnostics from the RAMI point of view are those that can lead to the stopping of the machine. The minimum number of diagnostics required to allow operation should be known. The function of each diagnostic and the minimum number needed to operate is shown in the following table:

Diagnostic	Quantity	Interceptive	Essential	Characterization
BPM	38	No	Yes, 3 out of 4	No
BLoM (safety)	57	No	Yes, 2 out of 3	No
uLoss	70	No	Yes, 1 out of 3	No
Profilers	8 pairs	No	Yes, only the last one	Yes, all
Interceptive profilers	5 pairs	Yes	No	Yes, all
Mean energy	3	Yes	No	Yes, all
Emittance-meter	1	Yes	No	Yes
Interceptive emittance	1	Yes	No	Yes
Energy spread	2	Yes	No	Yes, all
CT's	8	No	Yes, 6 out of 8	No
Bunch length	1	No	No	Yes
Allison scanner	1	No	No	Yes
Grid analyzer	1	No	No	Yes

Table 10.27 – Minimum number of diagnostics to operate and classification

10.6.1 Model description

The model done for the diagnostics corresponds with the PBS and considers only the essential diagnostics.

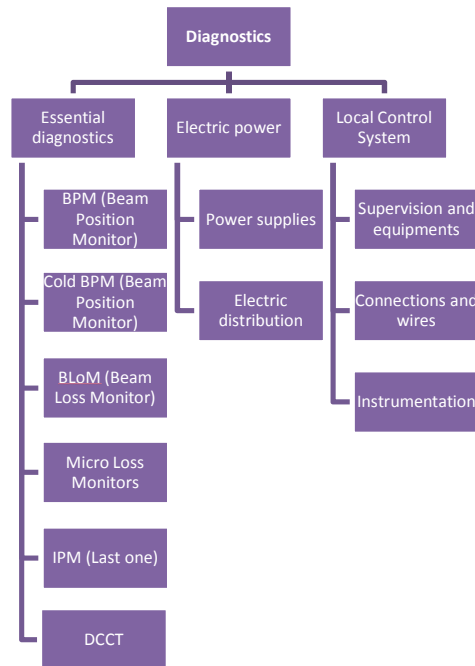

Figure 10.13 – Diagnostics model structure

10.6.2 Assumptions

a) Maintenance and operation assumptions

Only the essential diagnostics are required during operation. The necessary characterization diagnostics will be repaired during the maintenance periods in order to allow the beam characterization that is needed to restart the beam properly.

b) Design assumptions

It is considered that the design has few feedthroughs for the diagnostics in order to reduce the number of possible failures. As no specific design information has been found, the diagnostics connections in the reference design model have been centralized in order to reduce possible leaks.

c) Degraded operation modes assumptions

No possible beam degradation due to diagnostics failures has been modeled. Further studies should be performed to find possible implications.

10.6.3 Probabilistic analysis and results

a) Reference design availability results

	Mean availability	5%	95%
Diagnostics	99.58%	99.87%	98.79%

Table 10.28 – Hardware availability results for the diagnostics reference design

b) Importance of parameters and events

Component	Code	FC
Acquisition modules	1DGBDVEG003	$1.57 \cdot 10^{-02}$
Diagnostics boards	1DGBDDBG001	$1.46 \cdot 10^{-02}$
Cables	1DBVB240003	$1.39 \cdot 10^{-02}$
PLC	1DGBDPLH002	$1.15 \cdot 10^{-02}$
PC	1DGBDPCH003	$1.07 \cdot 10^{-02}$
PS	1DGNDPSG001	$8.51 \cdot 10^{-03}$
BPM sensors	1DGNDPSG001	$8.51 \cdot 10^{-03}$

Table 10.29 – Importance of diagnostics events

c) Possible design changes to improve availability

Redundancies and faster replacement, thanks to an easy maintenance design, have been assumed for the power supplies of the diagnostics. Control systems are considered to have redundancies and to have a modular and easily replacement design in components such as modules, boards, PLCs and PCs. Easiness in connections, feedthroughs and passthroughs has been followed reducing the number of possible failures.

d) Improved design results

	Mean	5%	95%
Diagnostics	99.58%	99.87%	98.79%
Diagnostics improved	99.67%	99.93%	99.00%

Table 10.30 – Comparison between hardware availability results for the diagnostics reference and improved designs

An increase in availability was achieved thanks to the improvements proposed. The mean annual unavailable time is about 27% that of the reference design.

10.6.4 Diagnostics RAMI analysis conclusions

The failure acceptance of this system makes good availability results possible. The availability requirement of 99.80% was not accomplished, but the results come very close. Failure acceptance should be confirmed in subsequent phases.

10.7 RF system

This is a complex system with many components that have quite high failure rates and low MDT. This low MDT is achieved through the modularity and an easily exchangeable design specifically developed to increase the availability. This design makes it possible to achieve availability results that are good but not as high as the requirements imposed. A solid-state alternative was proposed by the designers and was analyzed as a possible way to meet the requirements.

A logistic analysis was performed for the reference design. This was done because it seemed that this design would require many maintenance actions to be performed quickly in order not to compromise the availability.

10.7.1 Model description

The RF system model is comprised of different modules modeled individually and the auxiliary and control systems following the PBS. Components inside the modules have been divided between components which failure implies to extract the whole module and components that can be replaced without extracting the module (allowing an easy and quick maintenance).

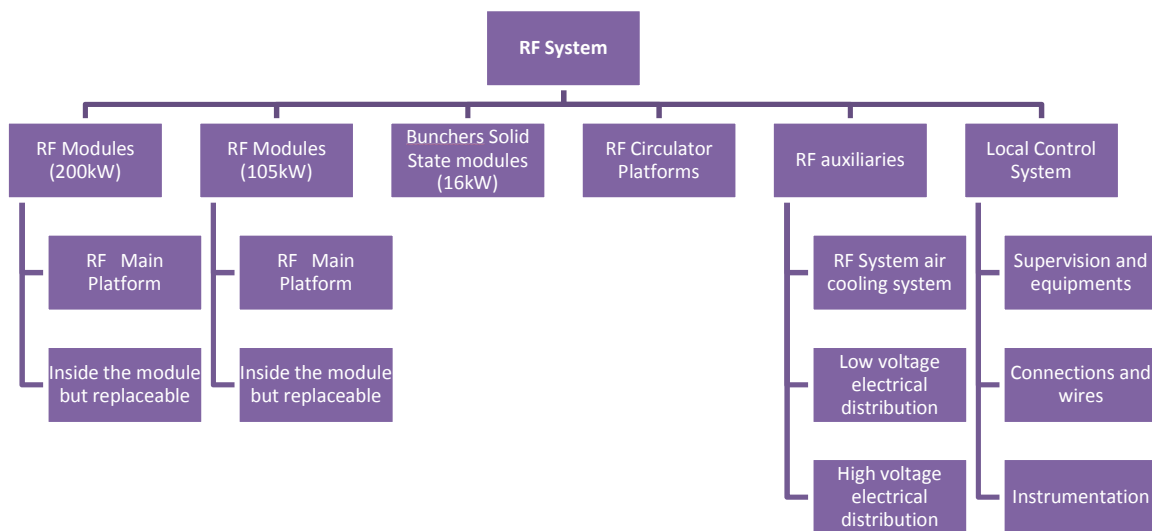

Figure 10.14 – RF system model structure

10.7.2 Assumptions and data used

a) Design assumptions

- Low-voltage power supply system

Fast replacement for spares assumed for power supplies.

- High-voltage power supply system

Fast replacement for spares assumed for high-voltage power supplies.

b) Tetrodes reliability data used

The tetrodes seem to be the most problematic components of the RF system. The data used for such components is described in this subchapter.

The data used to develop these calculations come from previous reliability data research done in the Fusion Energy Engineering Laboratory [30] and from specific accelerator reliability documents [40,53,118–125].

From LANSCE [119] it was extracted the FR of triodes of $1.4 \cdot 10^{-4} \text{ h}^{-1}$. Assessing this as a bad value, the document cites it as the reason why they are changing these components to new tetrodes and diacrodes.

From LHC [120][121], a FR value of $8.3 \cdot 10^{-5} \text{ h}^{-1}$ was extracted from the tetrodes replacement information. It is assumed that this value includes some tetrodes whose lifetime simply ended.

From the HERA proton accelerator [126], the failure rate of $1.3 \cdot 10^{-5} \text{ h}^{-1}$ for the tetrodes has been obtained. This data was obtained only from tetrodes replacement. Therefore, these values do not take into account the frequency of other failure modes where some maintenance is applied and the tetrodes have been used again.

With this data and other operational information [118,122–125] the reliability assumptions to make the analysis of this document are as follows:

- TH781 tetrodes failure rate will be modeled with a lognormal distribution with a mean value of $3.9 \cdot 10^{-5} \text{ h}^{-1}$ and an error factor of 10.
- TH561 tetrodes will have better reliability parameters due to the lower power and lower operation conditions under design normal operation. FR is a lognormal with a mean value of $1.95 \cdot 10^{-5} \text{ h}^{-1}$ and an error factor of 10.

From these failure rates, it is considered that two out of three times, the tetrodes will be repaired or conditioned and may be used again. One out of three times, the failure will be fatal and the tetrodes may not be repaired. This 1/3 failure rate matches with the HERA failure rate for fatal failures.

10.7.3 Probabilistic analysis and results

Previous analysis performed in 2011 in the Fusion Energy Engineering Laboratory [31] concluded that further RF amplifiers analyses should be performed. RAMI analyses done in this chapter contain individual reliability models for the RF modules and availability calculations for the RF system as a whole.

a) RF modules reliability model

The reliability analysis used fault tree models to assess the probability of having a determinate failure in the RF system. Each RF module model is composed by 267 basic events and 25 gates.

The circulator platforms will fail 3.4 times per year on average. The RF main platform will fail around 137 times per year, 78 of which could be repaired online, and 59 of which will require that the whole module be changed. In the event that the module will need to be changed, different actions should be performed depending on the cause of the failure. Logistic and maintenance analysis were performed based on these results.

Event	Annual failures	Mean time without beam (h)
Failure in the circulator platform	3.4	5
Any failure in the RF main platform	137	-
- Component failed inside the module but no extraction needed	78	2
- Failure in the module: replacement needed	59	4

Table 10.31 – Failures in RF system modules and platforms

The RF system is very complex; finding the cause of the trips is not simple. Sometimes trips are not due to a specific component but rather the sum of various components' behaviour. For example, from a LANSCE reliability analysis [40], the number of trips and the downtime of the RF system are classified depending on the part or subsystem that failed. A total of 59 trips out of 230 were due to an unknown cause. The unknown events were the third principal downtime contributor for the RF system.

This analysis takes into account some failures for which the cause was not clear. A 20% of additional failures were estimated with the RF system designers, and with the information found from other facilities.

In the event that the module will need to be changed, different actions should be performed depending on the cause of the failure.

Event	Failure rate for one module (h^{-1})	Percentage of failures	Annual failures for both RF systems
Tetrode failure	$1.17 \cdot 10^{-4}$	42.2%	48.0
Other components	$1.14 \cdot 10^{-4}$	41.2%	46.8
Unknown (+20%)	$5.60 \cdot 10^{-5}$	20.2%	23.0

Table 10.32 – Failures in RF main platform

b) Availability

A detailed model with 7,772 basic events and 620 gates was used to evaluate the availability of the current design of the RF system. The inherent availability result obtained was 94.06%. This result does not meet the requirement of 98.20% for the RF system. The power supply system does not have redundancies in the reference design.

A design similar to the one done in ESRF [112], in which a switching board connects a redundant power supply in the event of a failure, could be performed to improve the availability. With the current model and the data used, the maximum availability achievable with the current design, taking into account some plausible redundancies, would be 94.62%, less than the availability requirement (98.2%).

c) Number of events and contribution to unavailability

There are many events in this system due to the high number of components involved. Since the system is outside the vault, and the design was chosen to allow quick modules replacement, the MDT is low for all events. The only way to improve the system availability would be to improve the failure rate of the components, which can be very difficult to achieve. Better reliability performances could be required of components with high unavailability contributions, thereby improving the total availability. Tests and quality controls could be asked to ensure a determinate level of reliability.

d) First logistic support study: RF system

Logistic performance of module replacement, repair and set-up was studied. Simulations with different configurations and parameters were done to roughly determine the number of resources that affect the minimum to the accelerator availability. The analyses were done with dedicated spreadsheets and visual basic scripts through Monte Carlo simulations.

- System study and quantitative analysis

In Figure 10.15, the activities to be performed in the maintenance and logistics of the RF system are shown. On the left-hand side, circulator platforms (CLP) and RF modules are connected to the accelerator. When there is a failure in a module, it is replaced with a hot spare module. The failed module is moved to the warehouse workbench, where it is fixed. If a failure is caused by tetrodes, it is replaced in this workbench with a conditioned one. When the module is repaired, it is stored as a cold spare. When the hot spare workbench is empty, a cold spare module is placed in it to be prepared for operation.

Operations to be performed have been quantified in terms of time and manpower. Specific details, like the conditioning of tetrodes and different kind of problems, have also been considered in the study.

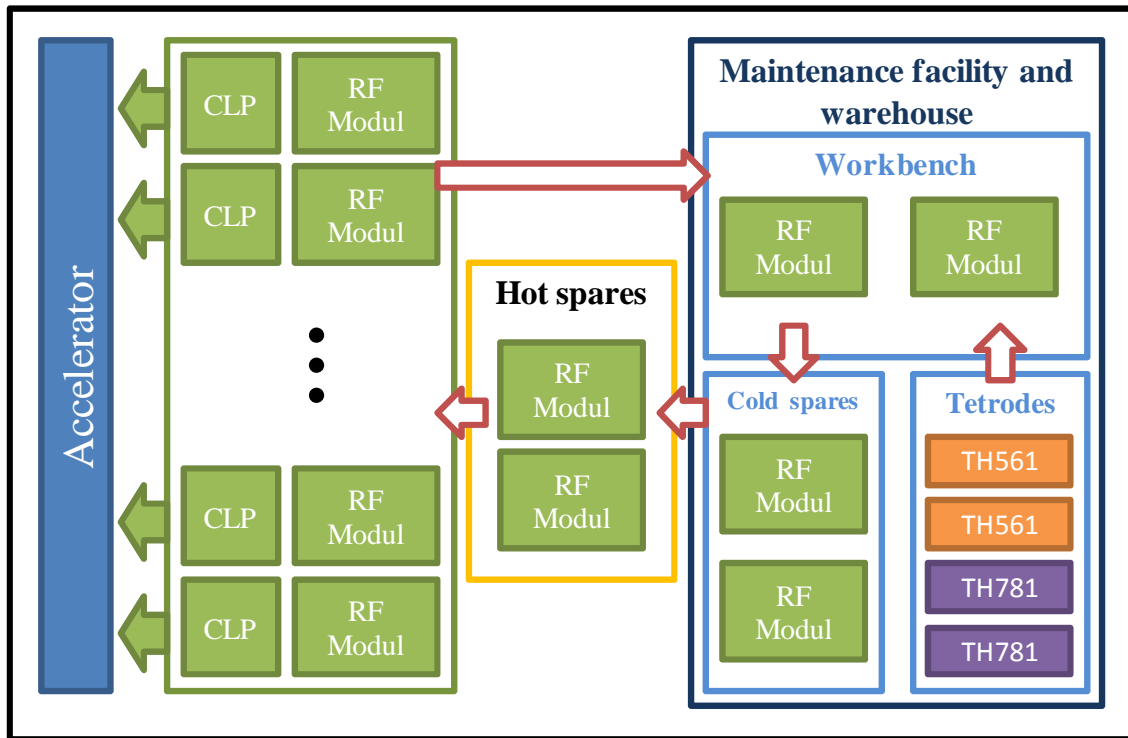

Figure 10.15 – RF modules and circulator platforms (CLP) logistics schema

Data used to perform this analysis come from the reliability and availability studies done in this subchapter. Maintenance tasks, times and personnel were obtained from RF system designers.

- Results

The result of the analysis done for normal operation showed that 4 workers must be available at all times to address the mean 260 maintenance operations that will occur every year in the RF system modules. About 110 operations will consist of failed module replacement, along with the resultant repair operations at the workbench.

Moreover, in order to perform module repairs, tetrode set-up, hot spare preparation and other regular activities, more than 11,000 man-hours will be needed annually. Three shifts of two men are recommended. A minimum of four 105 kW spares and five 200 kW spares are necessary to avoid affecting the availability. Two hot spare module workbenches for the 105 kW and three for the 200 kW are recommended.

One of the major concerns of this design is the tetrodes' lifetime. Filament lifetime is the cause of the short tetrode lifetime. The time required to obtain a new tetrode from the manufacturer is around 9 months for the TH781, and 6 months for the TH561. It is essential to properly plan the logistics of preparing spares.

A minimum lifetime of 10,000 hours is assumed for both TH781 and TH561 tetrodes. In order not to decrease the unavailability of the accelerator for the short lifetime of the tetrodes, all tetrodes will be replaced during the long maintenance period, after more than 8,000 hours of operation. This means replacing 200 tetrodes in 20 days, which is a challenging task. The replacement of the tetrodes in the scheduled maintenance period was not included in the manpower and workbench calculations.

Taking into account the spare modules, the replaced modules, the failed tetrodes, and the limited lifetime, the recommended quantity of tetrodes is 115 cold spares and 6 hot spares for the TH781 and 110 cold spares and 4 hot spares for the TH561.

- RF logistic support analysis conclusions

RF system availability has been improved with the modular design; however, this design needs to be analyzed more carefully from the logistic point of view to optimize the activities, manpower, spares and tools. This logistic study makes it possible to quantitatively estimate manpower hours, workbenches needed, operations to be performed, and spares. Space to perform such activities should also be analyzed and the building design should take this space into consideration.

Logistic support analyses can have an important impact on the total availability of the accelerator facility if not properly planned. In the analyses done in this thesis, it is assumed that there is no MDT increase due to logistics. Specific analyses should be done in the future to take into account the increase of downtime caused by logistics.

e) Possible design change: Solid-state alternative

Due to the improvement in the technology of solid-state amplifiers, the possibility of using this option for IFMIF RF system is becoming a very competitive alternative that presents from the beginning several advantages in terms of availability, reliability and logistics. The current design based on RF tetrode chains leaves no room for substantial improvements in terms of availability since the requirement for the RF system is hard to achieve. As a result, the RF system designers raised this alternative and a preliminary design in order to compare the designs in terms of availability, reliability and logistics. Moreover, these studies contributed to start a reliability-oriented design approach.

This alternative uses several modular solid-state power amplifiers (SSPAs) of about 1 kW to supply the desired RF power to each cavity. Each power chain of IFMIF could have the exact amount of power needed, with significant savings in installation costs.

The technology to combine these “low” SSPAs to achieve high power output does not present major difficulties and is used often in the industry. In fact, this technology is being used in other accelerator facilities like SOLEIL with an amplifying power per chain of 180 kW [127] and ESRF with 150 kW [128].

- Design description

In the solid-state case, the RF power system for IFMIF would be composed by 50 independent power chains supported by common auxiliaries. Each RF chain consists of a LLRF subsystem, a pre-driver, a splitter supplying the RF signal to the SSPA modules, and a combiner which provides the final output power [129].

Each SSPA needs certain components, such a DC converter, power cables, control cables and connections. This group of components has been called 'SSPA lines'. A failure in any of these elements implies the failure of the SSPA line but not necessarily of the whole RF chain. As hundreds of solid-state basic modules work in parallel to provide high output power, a failure in some of them only involves a negligible reduction in power [130] with a proper combining schema.

The transistor of each module is protected by a low-power circulator and does not need a high-power downstream circulator. Moreover, there is no requirement for a high voltage power supply.

- Data used

The data used in this analysis is mainly the same as that used in the tetrodes design analysis. Moreover, the SSPA module failure rate has been conservatively estimated to be $4.66 \cdot 10^{-6} \text{ h}^{-1}$ [131–133]. Therefore, each SSPA line (1 kW feeding) has a failure rate of $1.06 \cdot 10^{-5} \text{ h}^{-1}$.

- Redundancy optimization

The design accepts various redundant individual SSPA lines. In order to optimize such redundancy, some calculations were performed. A 120 kW (minimum 120 SSPA lines) chain was adopted as the reference amplifier [129].

The time required to repair all failed SSPA lines is conservatively assumed to be less than 72 hours, and the time needed to replace any other component was a maximum of 2 hours. Therefore, a big effort was made to minimize the number of times that the SSPA lines would have to be replaced. A reliability analysis of the components in each line was conducted. IFMIF's maintenance plan is comprised of a short 3-day stop after a half-year of operation, and a long 20-day period at the end of the year. It is assumed that the RF maintenance actions could be performed during both periods. Therefore, the reliability analysis was performed to ensure correct operation until the maintenance period.

The goal for every RF chain is to operate with all SSPA lines in a derated mode (extending the components life) and, when one line fails, to compensate for that loss of power with an augment of all the other power lines.

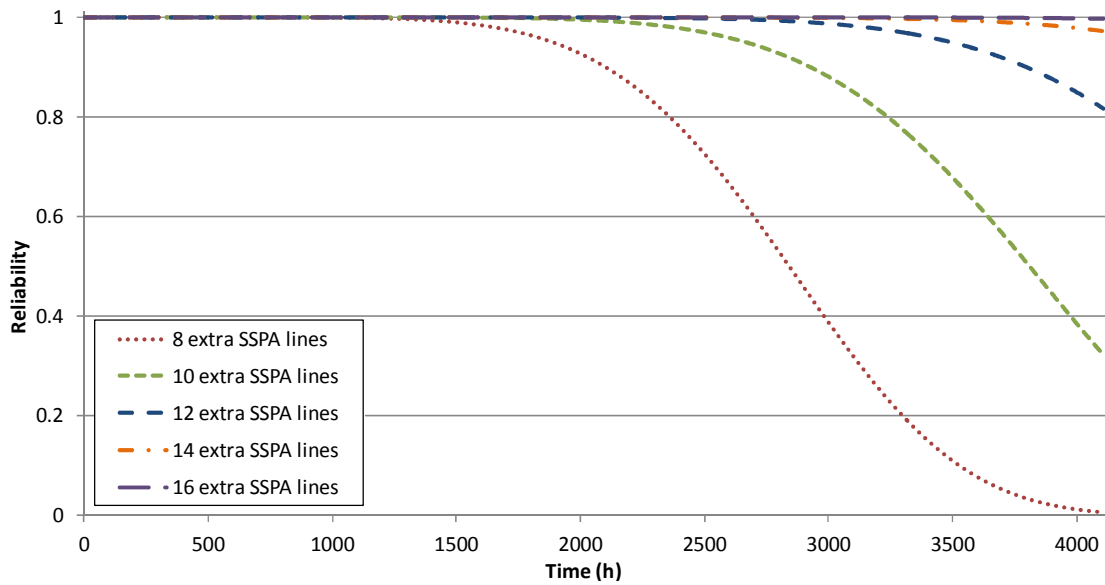

Figure 10.16 – Reliability for all SSPA lines of all chains for half year

The reliability after a half-year of operation (Figure 10.16) for all SSPA lines of all RF chains was 81.69% (99.60% for each chain) with 12 extra lines (a total of 132 lines). The number of failures due to these components for the whole RF system would be about one every 3 years of operation with 12 extra lines. The reliability would be 97.17% (99.94% for each chain) with 14 extra lines, which means about one failure every 15 years of operation.

- Availability calculation

The analysis of the whole RF system includes all of the components in each RF chain and the auxiliaries. Moreover, a common cause of failures has been calculated to be the large number of identical redundant SSPA lines. A partial beta model has been used to find the equivalent common cause failure rate [25].

Calculated availability of the RF system with the solid-state technology is 97.6% with 12 redundant lines and some basic redundancies in the auxiliary systems. To achieve the availability requirement of 98.2%, 14 redundant lines and some extra redundancies in power supplies and the cooling system would be needed.

- Maintenance and logistic analysis

On average, about 30 chains will require some replacements in their SSPA lines during both the short and long maintenance periods for each accelerator each year. This would indicate that extra manpower could be required in these periods.

The expected lifetime of a SSPA is more than 80,000 hours [134]. This implies a need to change the transistors every 10 years. Some of the SSPAs would be replaced before 10 years due to other failures, and the rest would be changed during the long maintenance period without affecting to the availability.

- Comparison between designs

The tetrode design option has improved their availability performance regarding previous designs through the increased ease of maintenance that was achieved by the use of modular boards; however, the solid-state alternative has better reliability performance due to the redundancy in the SSPA lines. This is translated into increased availability throughout the whole RF system.

Logistic and maintenance performance are much more demanding in the case of the tetrodes. This leads to an increase in costs, manpower, spares and other resources. Moreover, replacing 200 tetrodes in 20 days can be very challenging.

Using data obtained in previous studies [129,135] as well as information obtained in the current analysis, cost estimations have been obtained (Table 10.33).

	Tetrodes	Solid-state
Availability	94.62%	98.24%
Initial cost	87,500k€	105,500k€
Replacement cost	7,400k€/year	2,500k€/year
Manpower cost	1,200k€/year	400k€/year
Cost at 30 years	344.8M€	191.8M€

Table 10.33 – Comparison between both RF system alternatives. Values for the RF system of the two accelerators

More detailed cost estimations should be performed, but these rough estimates give a clear idea of the differences between these designs.

10.7.4 RF system conclusions

The solid-state option presents relevant improvements in terms of reliability, availability and maintainability and makes it possible to achieve the availability requirements. It also has less logistic performance and requires less manpower and spares. Cost estimations show that initial costs are slightly higher in the solid-state design, but are amortized after some years of operation.

Since it seems that SSPA design has many advantages regarding the tetrodes option, this alternative could be an adequate option for the definitive IFMIF design.

10.8 Accelerator facility auxiliary systems

The analyses performed for the water cooling system, vacuum exhaust system and the cryoplants were done by Tractabel SA. The main results of these analyses are explained in this chapter together with the results for the other auxiliary systems.

Hardware availability requirement for the auxiliary systems and the results obtained with the reference and the improved design models are:

	Availability requirement	Reference design availability	Improved design availability
Auxiliaries	99.40%	94.65%	99.10%

Table 10.34 – Auxiliaries’ hardware availability results

Hardware availability results for the subsystems:

	Reference design availability	Improved design availability
Cryoplant	96.31%	99.59%
WCS	98.90%	99.69%
Vacuum exhaust	99.52%	99.95%
Electrical distribution	99.87%	99.89%
Gas distribution	100.00%	100.00%
Common control system	99.97%	99.97%
Auxiliaries	94.65%	99.10%

Table 10.35 – Auxiliaries’ hardware availability results for each subsystem

An important increase in availability results has been achieved thanks to some redundancies:

- Water cooling system

The availability could be improved by considering two redundant cooling systems for the critical functions.

- Gas distribution

No improvement was proposed because availability results are good enough.

- Electrical distribution

MDT decreased for transformers and breakers assuming the use of prepared spares with easily switchable and modular components.

- Common control system

No improvement was proposed because availability results are good enough.

- Vacuum exhaust system

The availability was improved by considering two redundant connections to the AF systems (e.g., HEBT, SRF, RFQ) but keeping the common parts unchanged.

- Cryoplant

Two additional design options were considered for the cryoplant to improve its availability:

1. Same configuration as the reference case but one cold box with enough supply capacity to keep the two accelerators in operation (higher capacity than reference case); or
2. Configuration of three cold boxes, each one with enough supply capacity to maintain one accelerator in operation.

The result obtained for the reference case and the two other alternatives is provided in Table 10.36.

Design cases	Availability
Reference case	96.31%
Case 1	99.46%
Case 2	99.47%

Table 10.36 – Availability results for different design cases of the cryoplant

In case 1, the cold box with higher capacity allows maintaining the two accelerators in operation even if there is a failure in one cryoplant. This design decreases the number of failures that lead the accelerator without liquid helium, which in turn slightly increases the global availability.

Moreover, if a shorter length is considered for the distribution of the helium to the cryomodules (i.e., the interconnection is close to the accelerators), then the probability of failure of the supply to one accelerator can be decreased. The availability result obtained in case one and considering this improvement is 99.59%.

10.9 RiskSpectrum results and conclusions

Individual probabilistic RAMI analyses have been the principal studies done to estimate and improve the availability of the accelerator systems. Many design changes

have already been included in the reference design; however, major changes have been proposed for the main unavailability contributors in order to meet the high requirements. The main improvements proposed are shown in the following table together with their qualitative impact on the global accelerator facility availability:

System	Component or subsystem	Improvement or recommendation	Availability increase	Comments
Injector	Power supplies	Multilayer coils, automatic switch or permanent magnets	Low	If access time to vault increases this recommendation would have more relevance
	Extraction electrodes	Improved isolation	Medium	Preventive maintenance should fit within scheduled maintenance periods
	Vacuum pumps	Redundancy	Medium	Design change needed
MEBT	Buncher tuning system	Redundant step motors	Low	
	Scrapers	Easily extractable module	Medium	Cooling time can be high. Easy maintenance is essential
SRF linac	Leak-related components	Quality control	High	Every failure can lead to very large downtimes
	RF vacuum window	Double window	Medium	RF couplers design change needed
	Tuning system step motors	Redundancy	Medium	To increase reliability
	Cryomodules	Hot spares	High	Expensive
	Isolation vacuum pumps	Overdesign for possible leaks	Medium	Easy improvement
	Cavities and focusing elements	Failure acceptance	High	Reduction of beam parameters. Specific beam studies required
HEBT	Scrapers	Easily extractable modules	Medium	Cooling time can be high. Easy maintenance is essential
RF system	Amplifying chain	Solid-state	High	Change the design, technology not yet mature
Auxiliaries	Cryoplants	Higher capacity	Medium	
Other	Power Supplies	Automatic switch	High	Many power supplies could use this fast failure recovery design
	Control system	Redundancies and 2-out-of-3 configuration	Medium	Bad signals should not stop the accelerator

Table 10.37 – Mean hardware availability and mean beam intensity results

Moreover, RFQ modules can be very problematic due to their high likelihood of wear-out. An easy and quick maintenance procedure should be foreseen to replace the modules.

RiskSpectrum results show that the hardware availability requirements could be achieved with the improved design model. In the following figure, a comparison of both models and the requirements for each system are shown.

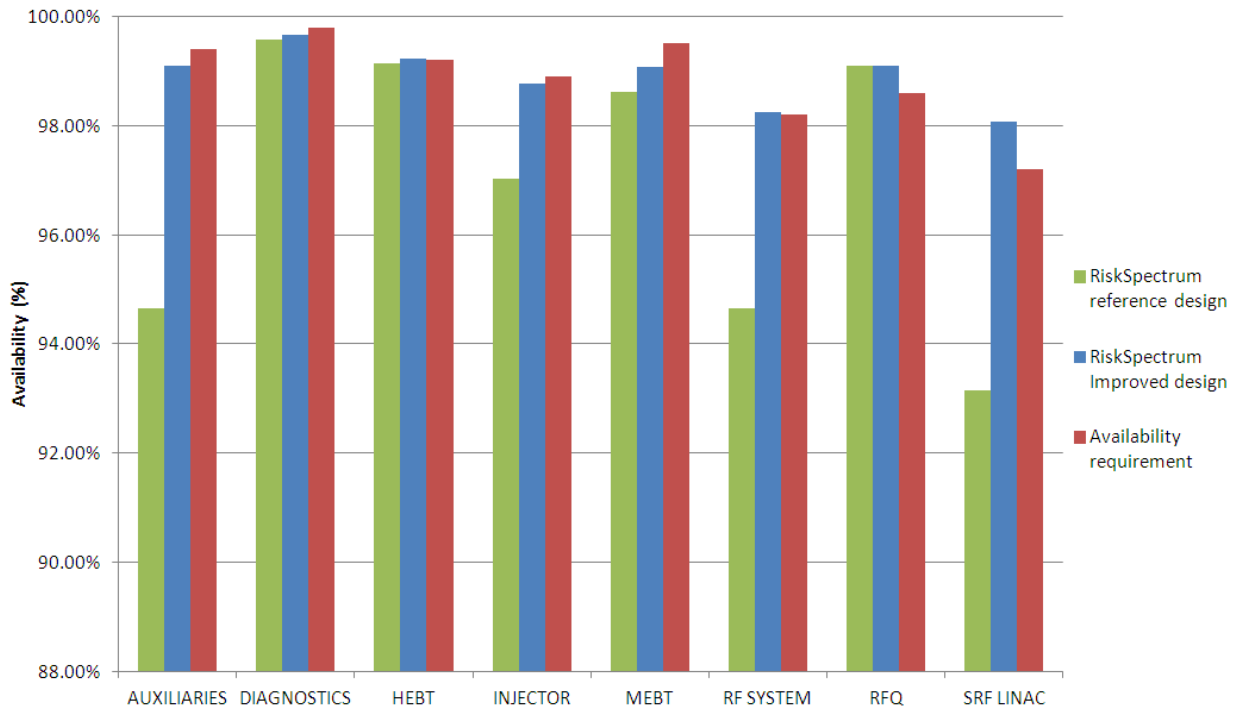

Figure 10.17 – Hardware availability results obtained with RiskSpectrum.

Hardware availability results obtained with RiskSpectrum for the reference design are 78.10%, while the improved design results are 91.57%, achieving the 91.10% of hardware availability requirement.

It is important to make clear that these results were achieved as a result of the acceptance of operating with beam degradation. As explained in Chapter 7, the hardware availability requirement was fixed considering a beam degradation of only 2%, and then assuming that the mean intensity would be 98% of the nominal intensity. As this degradation cannot be calculated with RiskSpectrum, an estimation has been made based on the reliability results.

Considering the probability of the failure of each component that could affect the intensity, and taking into account the intensity degradation that each component failure could cause, a rough mean intensity of 91% was obtained. This intensity value implies to have a BE of 88.73% and therefore a BA of 81.25%. With these values, the 95.5% BE requirement and the 87% BA requirement cannot be achieved; however, the product of hardware availability and intensity cannot be balanced with RiskSpectrum.

Probabilistic analyses are a very useful way to improve the design and to obtain detailed and specific results of each system but not to obtain global availability results for the accelerator facility as a whole. In the next chapter, a simulation is performed with AvailSim in which a beam intensity and hardware availability product optimization is performed in order to have a simulation which is more like the real operation.

Chapter 11

Availability simulation

Several problems arose when using generic reliability tools to perform RAMI analyses for the IFMIF accelerator. A dedicated simulation tool was necessary to properly model the complexity of the whole accelerator facility.

AvailSim, the availability simulation software used for the International Linear Collider (ILC), became an excellent option to meet the needs of RAMI analyses. Nevertheless, this software needed to be adapted and modified to simulate the IFMIF accelerator facility in a useful way for the RAMI analyses in the engineering design phase. Furthermore, some improvements and new features were added to the software. This software has become a great tool to simulate the peculiarities of the IFMIF accelerator facility, making it possible to obtain a realistic availability simulation. Degraded operation simulation and maintenance strategies are the main relevant features.

The effort of adapting this software to the IFMIF needs was done by Pere Joan Sureda in his final degree project [136]. This chapter describes the necessity of this software, the main modifications made to improve it, and its adaptation to IFMIF RAMI analysis. Moreover, results obtained with AvailSim 2.0 for the third iteration are shown.

11.1 Why a simulation?

RAMI analyses done in first and second iterations were based on fault tree calculations performed with RiskSpectrum software. Such calculations have strict rules that do not allow easy modeling of the accelerator operation. Some tricks and partial solutions made it possible to obtain models that adequately represented the availability

performance of the accelerator systems individually as seen in previous chapter; however, a calculation for the whole accelerator facility was not feasible.

When failure acceptance, beam degradation operation and maintenance policies had to be added, a simulation of the whole performance of the accelerator became necessary.

A simulation tool allows modeling of the accelerator characteristics in a way that would be impossible through calculations. Moreover, customized simulation software make it possible to take into consideration relevant parameters and complexities that reflect the behavior of the accelerator more accurately than commercial software packages do. The main drawback is that a simulation is more time-consuming in terms of computing than a calculation.

11.2 AvailSim 1.0

The availability simulation software called AvailSim 1.0, developed for the International Linear Collider (ILC) [79], was an excellent option to meet the needs of RAMI analysis.

Availsim 1.0 is a Matlab® Monte Carlo program that simulates the availability and beam characteristics of an accelerator. It simulates the continuous failure of components during the operation as well as the effect that those events have on the accelerator's performance. It allows flexible configuration of parameters like maintenance management, manpower requirements, and operational parameters among others.

The main features of this software include several ways that failures can degrade performance, it accepts different kinds of maintenance (e.g., vault access required or not, hot swappable or not), it contemplates turn-on recovery time (e.g., depending on failure, location and time expended), it takes into account manpower control, and it allows maintenance procedures customization (e.g., component priorities, kludges, wait until next scheduled maintenance period) [79].

However, AvailSim 1.0 had to be modified in order to be useful for the IFMIF RAMI studies. AvailSim 2.0 is the modified version of the software that includes the changes that were made to adapt it to IFMIF as well as some useful improvements.

11.3 How does AvailSim 2.0 work?

Generally speaking, AvailSim 2.0 works similarly to its predecessor; however, there are several changes that make it considerably different from the previous version.

AvailSim 2.0 simulates the development of two related elements: events and functions. Events represent the failure modes of the accelerator's physical components and other actions such as scheduled maintenance periods or periodic tests. Functions represent the accelerator operation parameters and the state of their systems. Moreover, buildings, facilities, rooms and locations as well as their characteristics (e.g., access time, maximum number of people allowed or radiation cool-down times) are included in the input data.

The software generates a timeline in which future events are placed. These events are generated following the probability distributions specified in the input data files. When simulation begins, the software takes the first event in the timeline and, depending on its nature and its implications, decides what must be done. For example, if it is a failure that has no impact on the accelerator operation thanks to a redundancy, then the operation continues; however, if the failure reduces a critical function below its threshold, then the software will stop the operation and plan the corresponding maintenance. In this case, the software will define which components will be repaired, how many people are required, and the time needed.

After performing the maintenance, the software analyzes if the parameters and functions are in an acceptable state to continue operation. If they are, it starts operation again and runs until the next event in the timeline.

The simulation continues until the established simulation time has ended. Then, the software summarizes and records all parameters and results. After that, it may start the simulation again to complete the specified number of iterations. Finally, the software calculates the mean results for all iterations.

11.4 AvailSim 2.0 new features

In this subchapter, the changes and improvements that were implemented in order to perform an adequate simulation for IFMIF are described.

11.4.1 Data and inputs

- Failure modes: Components can fail in more than one way. In the new version, every failure can have different consequences on the system and different repair times. There is more than one possible event for each component.

- Quantity: Unlike AvailSim 1.0, this version treats each component individually, considering specific consequences for each failure mode of each component.

- Group of events: Every component belongs to a bigger system that is directly affected by it. The aim of this indicator is to prevent an already failed component or system from further affecting the accelerator when another failure occurs in the same group of events.

- Input files: These files are text files in comma-delimited format. The structure has been adapted to the IFMIF databases and design information.

11.4.2 Functions and parameters

Failures are not easily accepted for the IFMIF accelerator. Nearly every failure forces a degradation of beam parameters in order to continue operation [3]. To be properly modeled, failure consequences require a complex tool. For this reason, functions have been modified to make them much more flexible in order to simulate the machine's peculiarities. Complex degraded operation and redundancies can be modeled (e.g., degradations shown in Chapter 8). Moreover, with these functions, it is possible to make models similar to fault trees.

There are three kinds of functions: standard, special and critical. Standard functions are used for any redundant or nonessential parameter. Special functions are used to gather different functions' values or to have different minimum limits. Finally, critical functions are the top functions – i.e., the ones that determine the operation and state of the facility.

Every function has a design value and a minimum value; if a function value is decreased below its minimum, it will degrade another function or halt the machine operation if it is a critical function. Functions can be affected by other functions or by components' failure modes. Functions and failure modes can affect more than one function and in different ways. They can decrease its value, multiply it by a factor, or set its value to a specified number.

Relationships between parameters can be included in function limits in order to stop the machine when different situations are reached. For IFMIF, it is assumed that operating with less intensity than the nominal is acceptable; however, beam intensity is directly related to the damage produced in the samples and therefore to beam availability. Consequently, if the beam intensity is too low, it may be preferable to repair the failed components than to continue in a degraded operation mode. The decision will depend on the amount of intensity degradation, the downtime to repair the component and the remaining time to the next scheduled maintenance period. This is explained in detail in subchapter 8.7.

11.4.3 Simulation iterations

A loop in which the software runs any number of iterations has been implemented. The results are statistically treated to obtain mean values, errors, standard deviation and confidence intervals among others.

As an example, Figure 11.1 shows a histogram of the availability obtained in 400 iterations of a 30-year simulation.

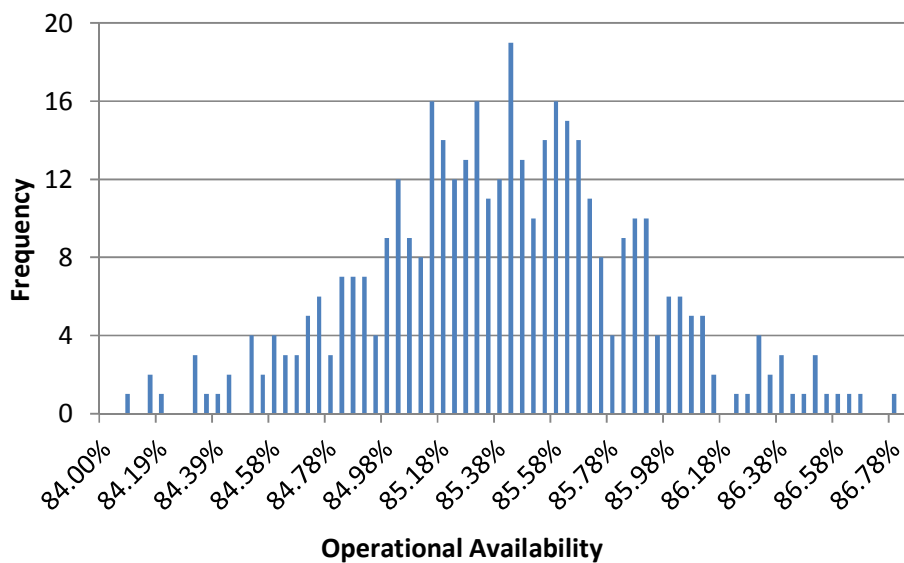

Figure 11.1 – Histogram for IFMIF accelerator facility operational availability results

11.4.4 Outputs

A great deal of details from a simulation run can be output if desired. The history files record all actions and events that occur during the simulation (as in the previous AvailSim version). However, the structure has been adapted to allow database queries in order to permit the easy extraction of information.

Components and their failure modes can be evaluated in terms of the size of their contribution to unavailability. Individual and combined information about number of failures and mean downtime can be obtained. Moreover, the results also include other information, such as maintenance when the accelerator is down due to another failure or times when the scheduled or unscheduled maintenance periods were increased to perform repairs due to a particular component.

Furthermore, data about the evolution of each facility during the 30-year simulation have been included to show the time dependencies of the parameters.

11.4.5 Other changes and improvements

As in the previous version, it is possible to introduce a parameter that defines how much the scheduled maintenance periods can be increased to perform nonessential maintenance actions. Moreover, in the new version, if a failure occurs before a scheduled maintenance period, the scheduled maintenance actions can be done during this non-scheduled downtime (e.g., preventive maintenance). These specifications can be defined in the input files.

In the new version, it is considered that all failures will not be repaired during the long scheduled maintenance period. Therefore, it is possible to start a new run with a failure in a non-essential component. This usually occurs when a scheduled maintenance has to be enlarged too much and there is no important degradation in beam parameters.

11.5 Software validation

Due to the unique nature of AvailSim 2.0, it is not possible to easily compare it with other software; however, tests, verifications and comparisons were done.

11.5.1 Basic simulation tests

Basic tests were done by performing simple availability analyzes using AvailSim 2.0 and RiskSpectrum (which is a validated software) and comparing the results. In these tests, the basic core of the simulation is checked after the addition of the new features.

The results showed that mean values for both programs had a difference of less than 0.002%. Moreover, more specific results such as lists of principal contributors were essentially the same in both cases.

11.5.2 Enhanced features verification

As there is no software with which to compare these features, an exhaustive check of the AvailSim 2.0 history file was done. This file contains every action done by the software during the simulations. All features were analyzed in numerous and specific situations.

11.5.3 Comparison with former IFMIF analyses

Previous IFMIF accelerator models done with RiskSpectrum were simulated with AvailSim 2.0. These models did not include the enhanced features but helped to ensure

that the whole facility could be equally simulated with AvailSim. Results were very similar to those obtained with RiskSpectrum.

11.6 Beam parameter evolution example

To illustrate the results obtained with AvailSim, and the differences from RiskSpectrum, an example of the evolution of the beam parameters and the accelerator operation is shown. Beam parameter evolution is also a very useful way to see the value of the functions in each moment of the simulation, which is especially useful to calculate the beam effectiveness. Moreover, it helps demonstrate the progression of the function's value through a cycle of operation in order to check how AvailSim responds to different events.

In AvailSim, every function has a record of its values throughout the simulation. It is interesting to examine the evolution of beam parameters. For example, the beam intensity, energy and energy overhead parameters are graphically presented in Figure 11.2. Here, several failures force decreases of beam parameters in order to allow continued operation.

In Figure 11.2, there are some events that imply the necessity to change beam parameters or to have a large maintenance period. These events are described as follows:

- 102 hours: Cavity frequency tuning system in cryomodule 4 became non-operative. Intensity needed to be reduced to 123.3 mA, and energy overhead to 0.4 MeV to continue operation. The software decides to continue operation because the degradation does not imply to reduce the beam energy below its threshold and the intensity is slightly degraded.
- 512 hours: A failure in another frequency tuning system in cryomodule 4 led to a reduction of intensity to 121.6 mA. Energy overhead was consumed, and beam energy decreased to 39.8 MeV. Beam degradation is still acceptable.
- 962 hours: A cavity in cryomodule 2 became non-operative. Intensity decreased to 112.9 mA, and energy to 39.6 MeV. The software decides to continue operation because it is preferable to continue operation with this beam until the next scheduled maintenance period than perform maintenance actions and restart with nominal parameters.
- 3,739 hours: A solenoid in cryomodule 3 fails. Intensity should be 101.5 mA in order to continue operation; however, this degradation would be too high. Maintenance starts to fix the most important failures and other possible failures if time and personnel are available. In this case, (as included in the simulation specifications in order to optimize operation), the preventive activities that should be done in the short scheduled maintenance period are

done in this unscheduled period because the next scheduled maintenance would start within the following month.

- **4,113 hours:** Restart operation after 16 days of maintenance with nominal beam parameters (125 mA, 40 MeV and 1 MeV of energy overhead).

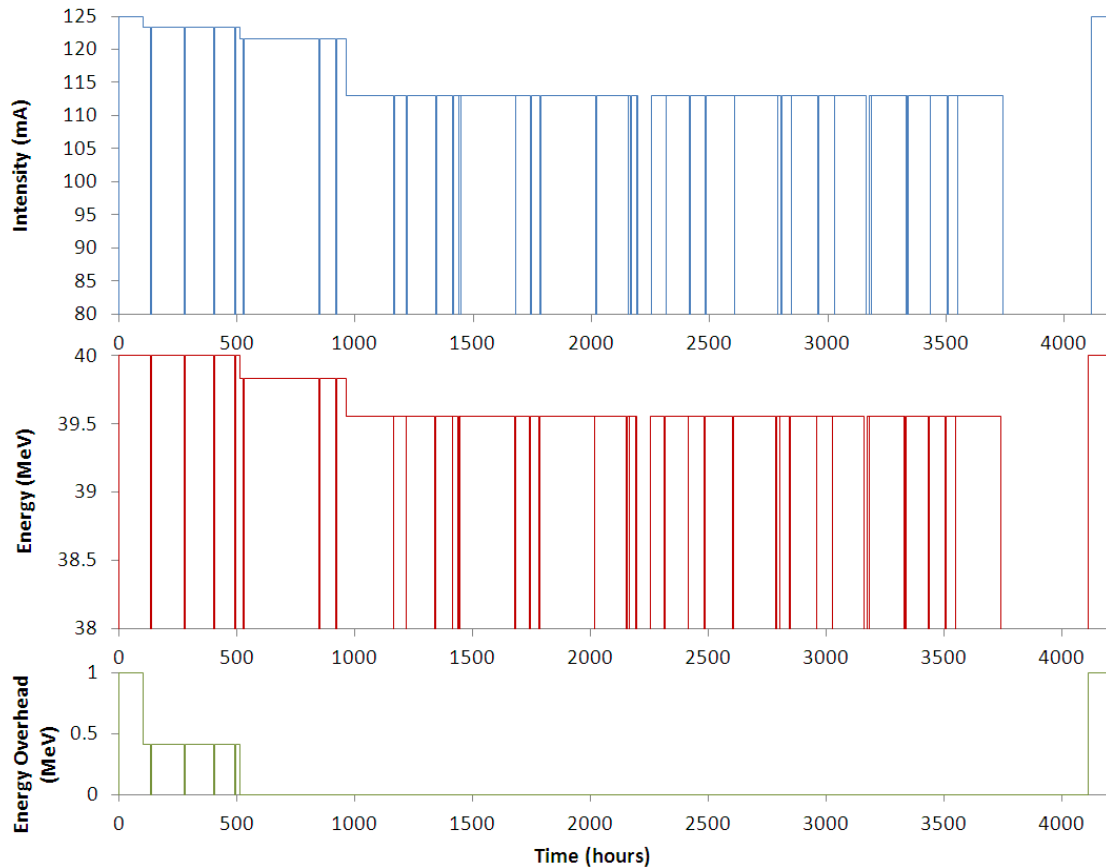

Figure 11.2 – Example of the evolution of the parameters obtained with AvailSim 2.0.

Moreover, in this example, some failures lead to the stopping of operations and the initiation of short corrective maintenance actions (each time the parameters go to zero and back to its previous value). In these cases, the software does not decide to extend the maintenance period in order to repair all other components because the parameters' improvement would not compensate the time lost.

Parameter degradations permit increased accelerator hardware availability at the expense of decreased beam effectiveness. Total availability performance can be highly improved thanks to this degradation and to the balance achieved between the parameters.

11.7 AvailSim 2.0 results

The results were obtained in 80 iterations of the 30-year simulation (maximum standard deviation $5 \cdot 10^{-3}$, maximum error $\pm 1 \cdot 10^{-3}$ with a confidence interval of 90% for global accelerator availability results). Two models were developed; one with the reference design and another with the improvements proposed. The design information, model description, and assumptions made are shown in the probabilistic analyses done with RiskSpectrum in Chapter 10.

11.7.1 Reference design results

The general results obtained for the reference design of the accelerator with AvailSim 2.0 are shown in Table 11.1. This information is relevant to understanding the global behavior of the accelerator. Furthermore, it is useful to forecast the importance of easy access to the rooms, for example, or the number of people required.

Parameter	Value
Accelerator operating	210,331 hours
Accelerator down (unscheduled)	35,908 hours
Scheduled maintenance	16,560 hours
Operational availability	80.03%
Hardware availability	85.42%
Vault access time	17,508 hours
Times the vault has been accessed	164 times/year
Maintenance extended	352 hours
Downtime used for scheduled maintenance	940 hours
Number of beam stops	2,521 times

Table 11.1 – AvailSim simulation results for the reference design

Operational availability result shown in Table 11.1 takes into consideration the scheduled and the non-scheduled downtimes without considering the effect of beam trips. Hardware availability is an inherent availability parameter that only considers non-scheduled downtimes. Number of beam stops includes all stops caused by failures (causing unscheduled downtimes) but not beam trips.

As can be seen in Table 11.2, the mean value for the intensity parameter for the reference design is 115.31 mA, which indicates that it stays at 92.25% of its nominal value. Mean energy and energy overhead values are also shown.

Name	Mean value	Design value
Energy	39.35 MeV	40 MeV
Intensity	115.31 mA	125 mA
Energy overhead	0.53 MeV	1 MeV

Table 11.2 – AvailSim Beam parameters results for the reference design

Availability results can be obtained for each system, subsystem or group of components. Availability results for each system can be seen in the following table. Auxiliaries were not calculated with AvailSim (because this system was analyzed by the external company Tractabel Engineering SA), and it has been assumed that the requirements were achieved.

System	AvailSim availability result	Availability requirement
Auxiliaries	94.65%	99.4%
Diagnostics	99.67%	99.8%
HEBT	99.16%	99.2%
Injector (& LEBT)	97.85%	98.9%
MEBT	98.90%	99.5%
RF System	95.28%	98.2%
RFQ system	99.26%	98.6%
SRF linac	94.42%	97.2%
Accelerator (TOTAL)	80.85%	91.1%

Table 11.3 – AvailSim hardware availability result for each system for the reference design

In this analysis, the availability results do not achieve the requirements imposed on each system. These results are quite similar to those obtained with the probabilistic analysis of Chapter 10.

11.7.2 Improved design results

Using the same improvements proposed in the RiskSpectrum analysis, the result obtained with AvailSim are as follows:

Parameter	Value
Accelerator operating	224,655 hours
Accelerator down (unscheduled)	21,405 hours
Scheduled maintenance	16,740 hours
Operational availability	85.48%
Hardware availability	91.30%
Vault access time	10,889 hours
Times the vault has been accessed	125 times/year
Maintenance extended	535 hours
Downtime used for scheduled maintenance	548 hours
Number of beam stops	2,521 times

Table 11.4 – AvailSim simulation results for the improved design

Table 11.5 shows the mean and design values of the accelerator parameters. The mean value for the intensity parameter for the improved design would be 119.85 mA, which indicates that it stays at 95.88% of its nominal value.

Name	Mean value	Design value
Energy	39.61 MeV	40 MeV
Intensity	119.85 mA	125 mA
Energy overhead	0.64 MeV	1 MeV

Table 11.5 – AvailSim beam parameter results for the improved design

Using the improved model, the results for each system are as follows:

System	AvailSim availability result	Availability requirement
Auxiliaries	99.40%	99.4%
Diagnostics	99.84%	99.8%
HEBT	99.04%	99.2%
Injector (& LEBT)	99.27%	98.9%
MEBT	98.97%	99.5%
RF System	97.91%	98.2%
RFQ system	99.25%	98.6%
SRF linac	96.71%	97.2%
Accelerator (TOTAL)	90.75%	91.1%

Table 11.6 – AvailSim hardware availability result for each system for the improved design

The results obtained nearly achieve the hardware availability requirements. It is important to note that in this case, the beam effectiveness is also increased thanks to the increase in beam intensity.

11.7.3 AvailSim results and conclusions

The AvailSim simulation has been very useful to obtain more adequate results for such a complex system. The relationship between hardware availability and beam parameters, and the balance between the two, make it possible to obtain much more realistic and interesting results than RiskSpectrum for an analysis of the whole accelerator facility.

Reference design and improved design results are compared with the requirements for each system in the following figure:

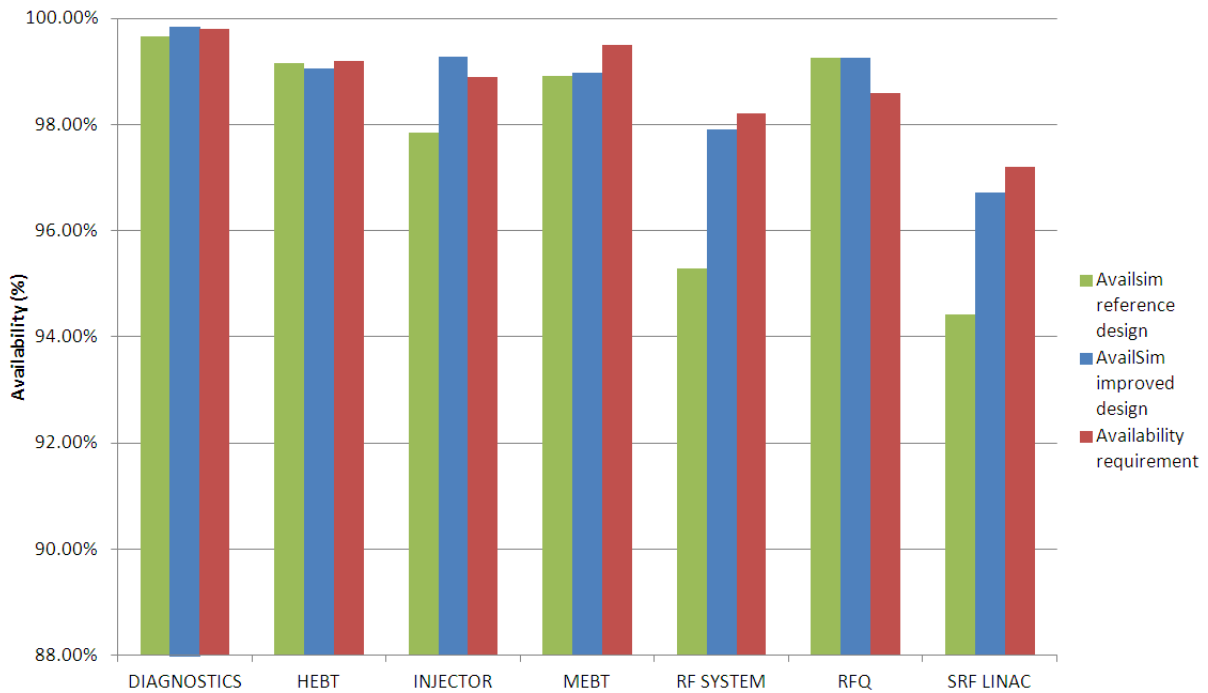

Figure 11.3 – AvailSim hardware availability results and requirements

The proposed improvements increase the results to nearly achieve the availability requirements and allow a better performance in terms of reliability and beam parameter degradation than the reference design. Moreover, the results show the mean values of the beam parameters, the availability of each system and other results such as number of vault accesses and manpower required. These results give an idea of the maintenance and logistics requirements and operations performances of the future IFMIF.

The results obtained with RiskSpectrum are compared to those obtained with AvailSim for each system in Figure 11.4. Some differences between both models are caused by the different limits of hardware availability acceptance. While only static limits are imposed for the RiskSpectrum model, for the AvailSim simulation an optimization on the product of beam intensity and hardware availability is followed.

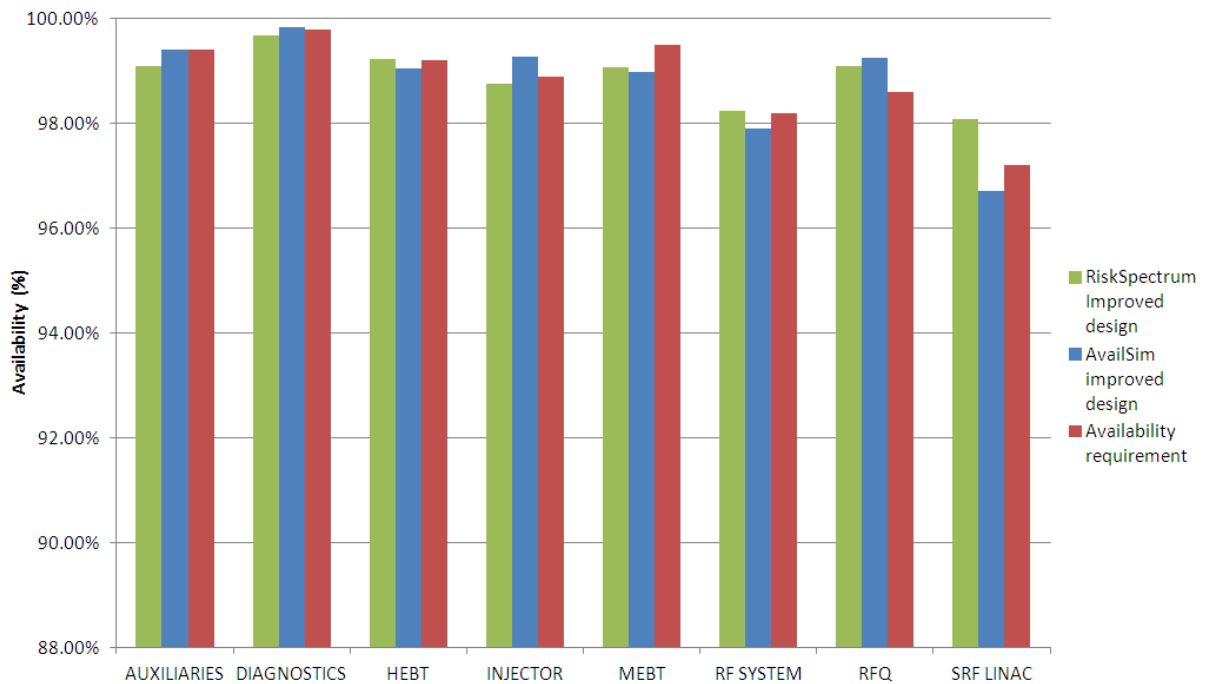

Figure 11.4 – Hardware availability results obtained with RiskSpectrum and with AvailSim

The consequence of such difference in the analysis implies divergences in the hardware availability and intensity parameters, as can be seen in next table.

Software	Hardware availability	Intensity	HA·I
AvailSim	90.75%	95.88%	87.01%
RiskSpectrum	91.57%	91.00%	83.33%

Table 11.7 – Mean hardware availability and mean beam intensity results for the improved design

The AvailSim result gives a better HA·I product value due to its parameter optimization.

As explained in Chapter 6, the beam effectiveness is calculated by the beam intensity and the beam trips. Assuming the beam trips calculated previously (97.5%) are valid for both cases, and considering the intensity values, the beam availability would be:

Software	Hardware availability	Beam effectiveness	Beam availability
AvailSim	90.75%	93.48%	84.83%
RiskSpectrum	91.57%	88.73%	81.25%
Requirement	91.10%	95.55%	87.00%

Table 11.8 – Mean hardware availability, beam effectiveness and beam availability results obtained with RiskSpectrum, AvailSim with the improved design models and the requirements

RiskSpectrum does not improve the beam effectiveness like AvailSim does, which implies to obtain results with higher hardware availability but lower beam availability. AvailSim’s capability to make realistic maintenance decisions and to simulate degraded operation modes makes it the preferred software for analyzing the behavior of a complex machine like IFMIF. Beam parameter results are more accurate and trustworthy than those obtained through probabilistic analysis.

AvailSim 2.0 has been implemented in a generic way in order to allow the simulation of any other facility; however, some modifications and adaptations could be necessary to simulate them properly. Although it is not complex software, many improvements can be implemented in order to make it more accessible and user-friendly. Graphical interfaces and flexible processing of input and output data could highly improve it. AvailSim 2.0 could be used to simulate all IFMIF facilities in order to see the relationship between them and quantify the availability of the whole IFMIF.

Chapter 12

Summary and conclusions

Availability estimations and design improvements were obtained after three RAMI iterations for the accelerator facility through the different analyses performed in this thesis. This chapter presents a summary of the analyses done, the results obtained and the conclusions drawn. Moreover, the achievement of the goals proposed at the beginning of the thesis and the proposal of future work are discussed.

12.1 Summary of the analyses and final results

The difficulty of achieving IFMIF accelerators' beam parameters and RAMI requirements becomes clear when compared with other facilities. Operation and maintenance cycles, availability requirements, and beam dynamics constraints make the design an arduous challenge. The knowledge gathered from other facilities (e.g., major problems encountered in similar accelerators, typical reliability and maintainability values and other useful data) was used to guide the RAMI analyses towards the most critical systems, components and parameters. Moreover, this information was treated to improve the reliability databases and was used for the inputs of the models. In addition, the results obtained in these RAMI analyses were compared with the operational data obtained from other facilities.

Individual probabilistic analyses were the principal studies done to estimate and improve the availability of the accelerator systems. Many design changes were included in the reference design; however, other major changes were proposed for the principal unavailability contributors in order to achieve the high requirements. SRF linac, RF system and the auxiliary systems are the systems that needed the most improvements to achieve the imposed requirements. For the auxiliary systems, some redundancies and some easy

changes were necessary to improve their availability. Nevertheless, SRF linac and RF system needed additional analyses and specific changes or improvements to achieve their goals. Major concerns were identified, and improvements needed to achieve the requirements were proposed, contrasted and analyzed.

Analyses of the reference design and the improved design were done for each system with RiskSpectrum; however, when analyzing the accelerator facility as a whole and when degraded operation became indispensable, an availability simulation software was needed. AvailSim became the perfect software to fulfill these needs after a laborious adaptation and improvement of its features. Thanks to these modifications, AvailSim permitted to take into consideration synergies between systems, degraded operation modes and realistic maintenance plans among other specific features.

AvailSim analyses demonstrated to be extremely useful to estimate the future operation and maintenance of the IFMIF accelerators. The beam availability results obtained with AvailSim for the whole accelerator facility for the reference and improved design models, along with the requirements, are shown in Table 12.1.

	Hardware availability	Beam effectiveness	Beam availability
Reference design	80.85%	89.94%	72.72%
Improved design	90.75%	93.48%	84.83%
Requirements	91.10%	95.55%	87.00%

Table 12.1 – Mean hardware availability, beam effectiveness and beam availability results obtained with AvailSim for the reference and improved designs, together with the requirements.

The reference design results have improved regarding the results obtained in previous analyses thanks to the design changes already included in it and to the optimistic assumptions made (which should be verified in subsequent project phases). However, the reference design results are far from the requirements. On the other hand, the improved design results come very close to the requirements proposed for each parameter.

The corresponding mean annual dpa production would increase from 5,969 to 6,963 full power hours (maximum of 8,208 hours annually considering scheduled maintenance periods). This would mean reducing the non-productive time from 2,239 to 1,245 full power hours, a decrease of nearly 45%.

The beam effectiveness results obtained with AvailSim are similar to the requirements. This parameter optimization should be pursued to improve IFMIF beam availability. Efforts to obtain better beam effectiveness values should be included in the design and commissioning phase.

Noteworthy, the results of these analyses are also related to operation and maintenance considerations which can have an impact on the final performance of IFMIF.

Some considerations and recommendations that have been proposed are: (i) beam dynamics studies and tests during commissioning are recommended to identify degraded operation modes and their consequences on beam parameters; (ii) possible problematic spots for maintenance and logistics have been highlighted; (iii) high quality control is recommended for components that have been selected as likely to become problematic; and (iv) possible problematic parameters, such as vault access time, cooling time for hands-on maintenance, restart systems time, and beam turn-on time and steps have been identified and should be carefully considered.

12.2 Conclusions

IFMIF accelerator characteristics imply several unprecedented challenges: the highest beam intensity, the highest space charge and the highest beam power. As a consequence of these challenges, many design characteristics are contrary to high availability performance: the design is reluctant to accept failures, machine protection systems are likely to interrupt the beam undesirably, cryogenic components require lengthy maintenance periods, and activation of components complicates maintenance actions. These design difficulties, together with the high availability requirements and the exigent scheduled operational periods, make the RAMI analysis an essential tool in the engineering design phase.

Even with several uncertainties, RAMI analyses have been performed in great detail. The results show that the hardware availability of the reference design (78.10% with RiskSpectrum and 80.85% with AvailSim) is insufficient to achieve the requirements (91.10%). However, if the proposed design changes to improve availability are considered, then the results come close to the requirements (91.57% with RiskSpectrum and 90.75% with AvailSim).

Several design changes are proposed. The ones that will have an important impact on the availability are to change the RF power system to solid-state technology, to have hot spare cryomodules for the SRF linac, and to include multiple redundancies in many ancillary systems. These proposals should be further evaluated before being included in the IFMIF accelerator reference design (e.g., safety and cost).

Moreover, to achieve such improvement, it is necessary to consider the capability of continuing operation with some failed components in the accelerator. Such failures would degrade the beam but would allow continued operation until the scheduled maintenance period. This option improves the hardware availability parameter but decreases the beam effectiveness. Beam effectiveness of the improved design obtained with AvailSim (which optimizes the beam effectiveness and hardware availability product) is 93.48%, while the estimation used to establish the requirements was 95.55%.

The beam availability results of the improved design obtained with the AvailSim analysis (84.83%) are close to the accelerator facility requirement (87%). The improvements and changes required to accomplish the 87% can be hard to achieve (technically and economically).

Many assumptions made in this analysis should be confirmed in future analyses or calculations. Beam trips, for example, can have a big impact on the beam availability if the experience of other facilities is not considered in the design. Final conclusions should not be drawn without considering the data, assumptions and estimations used to obtain the results.

The repercussion of the RAMI analyses in IFMIF should not only be estimated in terms of the availability results of the calculations and simulations performed. The inclusion of the availability requirements to each system and the incorporation of a RAMI team to monitor and look after its achievement made it possible to guide the design to a high RAMI performance. Thanks to the precociousness of these studies in the accelerator design, many possible future problems were eliminated from the root of the problem through initial iterations with the designers. Moreover, other possible problems were identified, and future analyses will ensure that they do not affect the global availability performance.

Excellent communication and a good predisposition were received from the different IFMIF teams to include the RAMI analyses in the design; however, in subsequent phases, the IFMIF accelerator design should focus not only on beam parameters like in LIPAc but also on the global machine performance. The IFMIF accelerator facility should be considered as an industrial facility that has to achieve high availability requirements. Efforts and resources should be focused on operation performance; otherwise, availability requirements will not be achieved.

Finally, it is noteworthy that these studies do not have precedents in experimental accelerator facilities from their early design stages. This made it difficult to obtain data and to find similar approaches but permitted to open the way to develop new methodologies and tools in order to include the RAMI analyses into the IFMIF accelerator design.

12.3 Goals achieved

The goals proposed at the beginning of this thesis were achieved. The goals and how they have been achieved are explained here.

- *Define and execute a methodology to include the RAMI analyses in the IFMIF accelerator design.*

The methodology was successfully defined and executed. The RAMI analyses were done together with the designers and were satisfactorily integrated in the design. After three iterations, RAMI analyses achieved an excellent model detail in accordance with the documentation and with the knowledge of designers and experts. Moreover, RAMI recommendations and concerns were considered and supported by accelerator designers and the IFMIF project team.

- *Choose, develop and adapt adequate tools to conduct the analysis of the accelerator.*

Due to the different natures of the software programs and their features, several tools were used for these studies to achieve a complete analysis of the accelerator. Full knowledge of RiskSpectrum software was necessary to adapt the inputs and to facilitate model modifications in a quick and effective way. Choosing AvailSim as well as adapting and using it for IFMIF have led to clear improvements in the calculation of accelerator facility availability and operation parameters.

- *Carry out the RAMI studies to analyze the design in the different design phases.*

Following the established methodology, the design was successfully analyzed through the different iterations in coordination with the designers, accelerator experts and the other RAMI team members. The analyses and tools were adapted and focused on the most important aspects of each moment. Moreover, design alternatives were compared and evaluated to provide designers with RAMI assessments about the different possible designs options through the design process.

- *Find weak points of the design, propose improvements, and give recommendations to enhance the availability performance in an effort to achieve the availability requirements.*

Many design changes and recommendations were extracted from these analyses to increase the availability of the accelerator facility. Some of these changes have been already included in the IFMIF design. Other improvements require further evaluation before being accepted in the reference design. Recommendations and issues to consider during design, fabrication, commissioning and operation have been highlighted in order to foresee possible problems related to RAMI. Thanks to these improvements, the availability has been greatly increased and the availability requirement has nearly been met.

12.4 Future work

The unique design of several components and the extremely demanding operational performance make it difficult to estimate their reliability without many uncertainties. Several components and systems should have specific and detailed reliability programs to test and verify correct performances. LIPAc will be a perfect test bench for such analyses.

Fault tolerance designs should be considered (i.e., the capability to maintain beam operation within nominal conditions under a wide variety of accelerator component faults). Beam dynamic studies should be done in order to estimate more precisely the consequences of failures on the beam behavior. In the commissioning phase, experiments could be made to create an accelerator-tuning database for each failure. This would be a useful way to ensure that such failures could be accepted with reasonable beam degradation and allow faster machine tuning during the IFMIF operation phase.

Beam trips must be carefully studied to better estimate frequency and duration. It would be interesting to find principal contributing factors, and to take palliative actions. A flexible machine protection system should be pursued.

Logistics analyses could be done to simulate the whole accelerator facility in order to identify problems from this perspective. Problems derived from logistic performance should not contribute towards an increase in accelerator unavailability.

An accelerator turn-on sequence should be done to estimate the time required in each beam restart case. A further detailed sequence could be performed. The aim would be to find weak points and to optimize the sequence in order to lose as little time as possible. LIPAc will provide essential information for the estimation and optimization of the sequence.

AvailSim has been shown to be an essential tool to evaluate the accelerator facility availability and beam parameters. This software has great potential to calculate more parameters, other design choices, and possible maintenance policies among others. AvailSim could be used to model all IFMIF facilities, evaluate synergies between them, consider global turn-on sequences, and analyze common functions. The efforts made to adapt this software to IFMIF should continue implementing new modules in order to enhance its capabilities and allow further and wider simulations.

All IFMIF members should take operation and maintenance plans into consideration due to the demanding availability and maintainability requirements. Maintenance strategies should be linked to the accelerator design and operation performances. Maintenance and logistic activities should be anticipated when designing the accelerator, the auxiliaries and the buildings for possible lack of space and easier maintenance.

A maintenance plan should be created ahead of time for components in cryogenic conditions. Experiences of other facilities and expert opinions should be gathered to decide if a dedicated maintenance plan might be necessary.

No beam reliability requirements were considered up to now. As explained in this thesis, it is expected that many beam stops of different durations will occur every day in normal operation. The consequences of such beam stops should be considered in other IFMIF facilities (test and target). An important impact on the accelerator design is expected if reliability requirements are imposed.

Appendix A

RAMI analysis description

In this appendix, the methodology of the RAMI analyses performed in this thesis is explained through some examples. The process is explained taking into account which information is used, how it is treated and which tools are used.

As explained in Chapter 5, the process mainly consisted in, first, gather information from the design and organizing it following the PBS structure. Once the components and subcomponents were identified and included in each system and subsystem, their functions were obtained. Then, an FMEA was done to find component's failure modes and their consequences. After that, model inputs were included in a spreadsheet to export them to RiskSpectrum or to AvailSim. Finally, a model was created and analyzed in order to evaluate their RAMI performances.

The analyses can be done for only a system or a subsystem or for the whole accelerator facility. RiskSpectrum permit performing analyses for both reliability and availability models. However, some adaptation was necessary to evaluate availability in some systems due to some limitations of fault tree calculations. In the AvailSim case, only availability simulations can be done.

A.1 PBS example

The PBS follows a numeration that structures all facilities, systems, subsystems, components and subcomponents through a PBS number. As can be seen in table A.1, the first number represents the facility (4 corresponds to the accelerator facility), the second

one is for the number of the accelerator (in this case is accelerator 1), the third is for the accelerator system (4 for the SRF linac) and the rest for subsystems (e.g. cryomodule 1), components (e.g. HWR cavity) and subcomponents if needed.

PBS number						
4	1	4	0	0	0	SRF linac
4	1	4	1	0	0	Cryomodule 1
4	1	4	1	1	0	HWR cavities
4	1	4	1	2	0	Frequency Tuning system
4	1	4	1	3	0	Solenoids
4	1	4	1	4	0	Steerers (H&V)
4	1	4	1	6	0	RF Couplers
4	1	4	1	8	4	Beam tube and ancillaries
4	1	4	1	9	5	Phase separator
4	1	4	1	10	7	Connections in the cryostat
4	1	4	1	11	8	Supports
4	1	4	1	12	1	Cryostat structure
4	1	4	2	0	0	Cryomodule 2
4	1	4	2	1	0	...

Table A.1 – PBS example

With this structure, all components are included in their systems and subsystems in order to establish to which part of the facility they belong. The PBS permit to establish requirements for systems and subsystems identifying boundaries between them.

A.2 Basic component’s functions

From the systems, subsystems and components, principal functions were extracted in order to foresee possible consequences of their failures in the global machine performance. These basic functions are only informative and were used to generate the FMEA. Some examples are shown in Table A.2.

Functions
Beam acceleration
Beam focusing
Cavity tuning
RF power supply
Cryogenic isolation vacuum
...

Table A.2 – Functions examples

A.3 FMEA

The FMEA consists in finding component's failure modes and their consequences together with possible corrective actions. Implications in unavailability were included in this analysis in order to consider them or not in the models. An example of a simplified FMEA is shown in table A.3.

Component and failure mode	Consequences	Corrective action
HWR cavities		
Structure deformation	No beam acceleration	Detune cavity and adjust accelerator. Repair it in next long maintenance period
RF antenna bad contact	No beam acceleration	Detune cavity and adjust accelerator. Repair it in next long maintenance period
Leak on cavity weld	Loss of beam vacuum	Clean nearby cavities and replace the failed one
...
Frequency Tuning system		
Step motor (no response)	Bad cavity tuning	Increase RF power if needed. Repair it in next long maintenance period
Screw and lever arm failure	Bad cavity tuning	Increase RF power if needed. Repair it in next long maintenance period
...
Solenoids		
Coil cable failure	Wrong beam transverse focusing	Detune next cavity and adjust accelerator. Repair it in next long maintenance period
...

Table A.3 – FMEA example

The consequences shown in the FMEA come from individual events; however, consequences of multiple failures were also analyzed and included in the models.

A.4 Model inputs

The main inputs for the models were created in spreadsheet files using reliability databases, specific operational information and expert's knowledge. These files were used to export the inputs to RiskSpectrum or to AvailSim automatically.

Reliability and maintainability data were included in these file to represent the probability of failures and their consequences. Data regarding failure detection times, access times to the location and activation cooling time among others were also included in these files.

The structure of these files is similar to the PBS. Each row represents a Basic Event or a Gate. Columns give information of the basic event or the gate. Table A.4 shows the information included in each column.

Column header	Description
Name	Gate or Basic event name
Quantity	Defines the number of Basic Events or Gates for that row. If it is a gate, every basic event or gate inside it (in an inferior level) will be multiplied for that value
Facility	Number of the facility or accelerator analyzed
System	System in which the gate or basic event belongs
Location	Physical location of the component
Recovery time	Time needed to recover the system in case of failure
Kind	Defines if the row is a Basic Event or a Gate and the deepness of the gate in the fault tree. Top Gate – Gate – Subgate – Subsubgate
Component Code	The code of the component used to model the failure
Failure mode	The code of the failure mode of the component used to model the failure
Function Code	The function of the component failed
ID	Basic event or gate identification code
Last number	Used for multiple exports
Type of gate	To define the Gate as OR, AND or K/N (only RiskSpectrum)
Type of Model	Defines the model used to represent the basic event (only RiskSpectrum)
State	State of the basic event (failed or not failed) when starting the analysis (only RiskSpectrum)
FR and MDT code	Code used to identify the parameters for different groups of components
FR	Failure rate of the basic event
MTTR	Mean time to repair the failed component
Access time	Time needed to access the location where the failure occurred (activation reduction, physical barriers...)
Recovery time	Time needed to recover the system failed
MDT	Time needed from beam stop to beam restart
Manpower	Rough estimation of manpower needed for repairing
Function affected	Function affected when the event occurs. More than one affected functions are possible (only AvailSim)
How?	How the function is affected when the event occurs (only AvailSim)
How much?	How much the function is affected when the event occurs (only AvailSim)
Group of components	Used to define groups of components that cannot degrade more than once the function affected (only AvailSim)

Table A.4 – Inputs model spreadsheet columns description

These columns heading can be used to understand the Appendix B (in electronic format) with all input files used for the final model analyzed. The example shown in this chapter only has the essential headers for edition simplification.

These files include information for both AvilSim and RiskSpectrum inputs exportation. However, in this appendix, it has been divided in table A.5 for RiskSpectrum and in table A.7 for AvilSim for explanation purposes.

These files are very useful to group repetitive components and systems. Gates and basic events have a quantity column to describe how many identical gates the model will have (considering all sub-gates and basic events below that gate). For example, in table A.5, there is a gate called “HWR not operative” and 42 gates called “HWR” and each one will have 4 basic events below them. This means that there will be 168 basic events below the “HWR not operative” gate.

A.5 RiskSpectrum model

RiskSpectrum analysis is based in a fault tree model in which basic events are connected through logic gates (Boolean operators). Failures in basic events are considered as the logical value of 1 and no failures as 0. The resultant Boolean equation gives a value for the probability in the top gate.

The models introduced in RiskSpectrum can be for reliability or for availability calculations. In availability calculations, each basic event has its own unavailability probability expressed as:

$$Q(t) = \frac{\lambda}{\lambda + \mu} \cdot [1 - e^{-(\lambda + \mu) \cdot t}] \quad (\text{A.1})$$

Where λ is the failure rate and μ the inverse of the down time.

Table A.5 shows an example of input data required for RiskSpectrum model.

Appendix A – RAMI analysis description

Name	Qty.	Kind	FR (h-1)	MDT (h)	Gate	Model
SRF linac	1	Top Gate			AND	
HWR not operative	1	Gate			3	
HWR	42	Subgate			AND	
Step motor (detune cavity)	1	Basic Event	6.25E-07	363		1
Structure	1	Basic Event	1.00E-08	1,850		1
Tee transition	1	Basic Event	1.00E-07	1,850		1
Bad soldering (antenna bad contact)	1	Basic Event	6.00E-08	1,827		1
Frequency Tuning system not operative	1	Gate			5	
Frequency Tuning system	42	Subgate			AND	
Step motor (no response)	1	Basic Event	1.25E-06	363		1
Screw and lever arm	1	Basic Event	1.00E-08	364		1
Electrical wire (Step motor power)	4	Basic Event	7.10E-07	363		1
Electrical connection (Step motor power)	4	Basic Event	5.00E-07	363		1
Solenoids not operative	1	Gate			2	
Solenoid	21	Subgate			AND	
Solenoids (inner and outer)	1	Basic Event	1.00E-07	1,834		1
Brazing joints	2	Basic Event	1.00E-08	363		1
Liquid helium Cooling channels	1	Basic Event	9.84E-09	366		1
Bellows	1	Basic Event	1.60E-08	369		1
Flange	2	Basic Event	5.00E-09	364		1
Weld	6	Basic Event	4.80E-09	372		1
Cryomodule 1 fatal failures	1	Gate			AND	
Leaks in HWR and tuning system	8	Subgate			AND	
Welds HWR structure	2	Basic Event	2.40E-08	1,836		1
Flexible membrane	1	Basic Event	1.00E-07	1,828		1
Plunger	1	Basic Event	1.96E-08	1,829		1
Welds Plunger	1	Basic Event	4.80E-09	1,836		1
Flange and gasket	8	Basic Event	5.00E-09	1,828		1
Leaks or failures in RF Couplers	8	Subgate			AND	
RF vacuum window (ceramic)	2	Basic Event	1.22E-07	1,836		1
...

Table A.5 – Inputs model spreadsheet example

The analyses are performed for the chosen top gate. In this example shown in Figure A.1, the analysis is done for the SRF linac system.

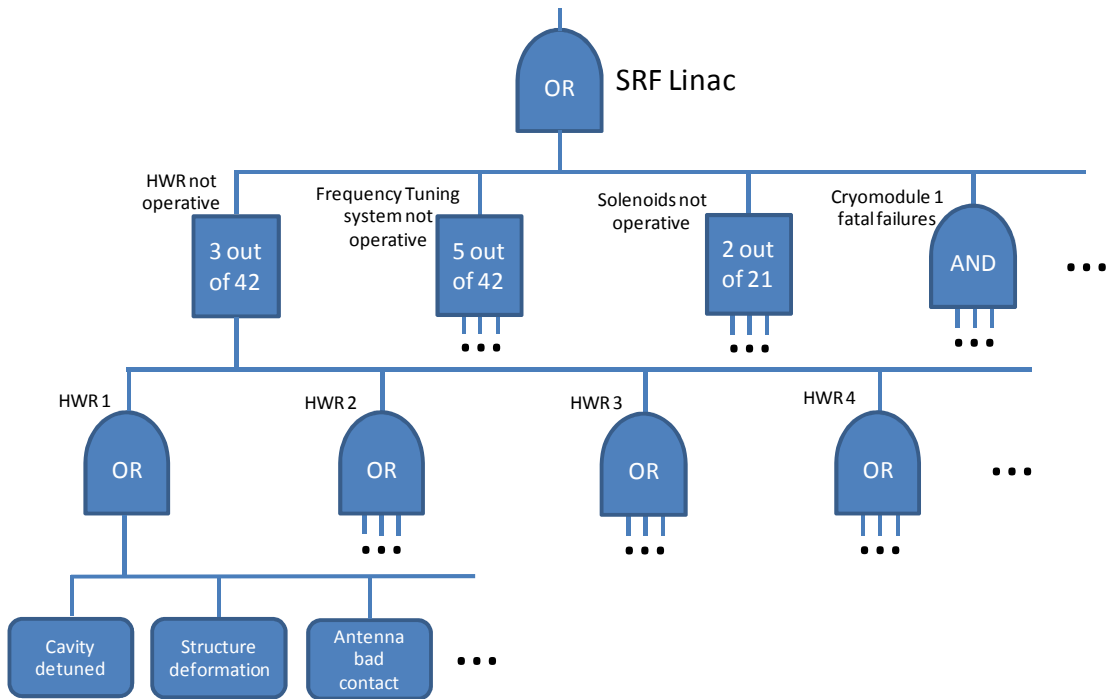

Figure A.1 – RiskSpectrum fault tree model example

A.6 AvailSim model

AvailSim needs to establish functions and their relationship to simulate their effect in the accelerator performance. As explained in Chapter 11, these functions can have different configurations and can represent parameters, relationship between components or system’s functions. An example of the functions used is shown in Table A.6.

Facility	Function	Design value	Min value	Function affected	Mult/add	Degradation	Level
A1	Beam	1	1				
A1	Energy	41	38	Beam	Mult	0	0
A1	Intensity	125	65	Beam	Mult	0	0

Table A.6 – AvailSim functions examples

Many other intermediate and auxiliary functions were included in the real model.

Table A.7 shows the main inputs needed for the AvailSim model. As can be seen, the functions affected by the failures and their impact in these functions (or parameters) can be specified.

Name	Quantity	Kind	FR (h-1)	MDT (h)	Function affected 1	How?	How much?	Function affected 2	How?	How much?
SRF Linac	1	Top Gate								
HWR not operative	1	Gate								
HWR not operative in C1	8	Subgate								
Step motor (detune cavity)	1	Basic Event	6.25E-07	363	Intensity	Add	-22.87	Energy	Add	-0.5
Structure	1	Basic Event	1.00E-08	1,850	Intensity	Add	-22.87	Energy	Add	-0.5
Tee transition	1	Basic Event	1.00E-07	1,850	Intensity	Add	-22.87	Energy	Add	-0.5
Bad soldering (antenna bad contact)	1	Basic Event	6.00E-08	1,827	Intensity	Add	-22.87	Energy	Add	-0.5
HWR not operative in C2	8	Subgate								
Step motor (detune cavity)	1	Basic Event	6.25E-07	363	Intensity	Add	-17.34	Energy	Add	-0.55
Structure	1	Basic Event	1.00E-08	1,850	Intensity	Add	-17.34	Energy	Add	-0.55
Tee transition	1	Basic Event	1.00E-07	1,850	Intensity	Add	-17.34	Energy	Add	-0.55
Bad soldering (antenna bad contact)	1	Basic Event	6.00E-08	1,827	Intensity	Add	-17.34	Energy	Add	-0.55
...
Frequency Tuning system not operative	1	Gate								
Frequency Tuning system in C1	8	Subgate								
Step motor (no response)	1	Basic Event	1.25E-06	363	Intensity	Add	-11.44	Energy	Add	-0.25
Screw and lever arm	1	Basic Event	1.00E-08	364	Intensity	Add	-11.44	Energy	Add	-0.25
Electrical wire (Step motor power)	4	Basic Event	7.10E-07	363	Intensity	Add	-11.44	Energy	Add	-0.25
Electrical connection (Step motor power)	4	Basic Event	5.00E-07	363	Intensity	Add	-11.44	Energy	Add	-0.25
...
Cryomodule 1 fatal failures	1	Gate								
Weld leak	16	Basic Event	2.40E-08	1,836	Beam	Mult	0			
Flange leak	8	Basic Event	5.00E-09	1,828	Beam	Mult	0			
...

Table A.7 – Inputs model spreadsheet example

An example of the relationship of the events and functions and their repercussion in the system is represented in Figure A.2. As explained in Chapter 11, intensity and energy parameters have their design values (125 mA and 40 MeV respectively) and if their value is below a certain threshold, the accelerator will stop (beam function to zero) and maintenance tasks will be performed.

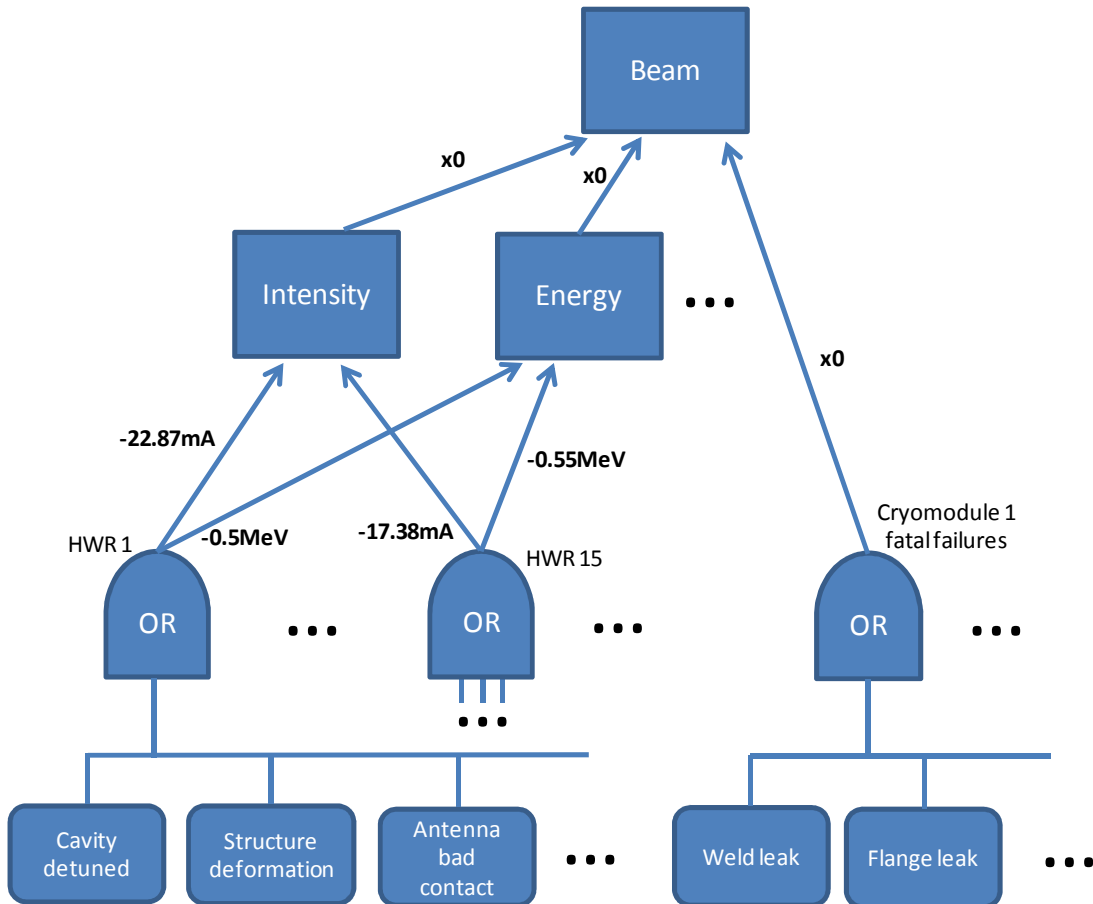

Figure A.2 – AvailSim simulation model example

As explained in Chapter 11, other generic data like scheduled maintenance operations or manpower is required to establish simulation details.

A.7 Results

RiskSpectrum provides powerful tools and analyses to find out interesting data in the results obtained. Some examples are sensibility analyses, parametric studies, time dependencies and importance analyses.

AvailSim does not have yet integrated specific tools to analyze the results. It is necessary to extract all simulation information and analyze it externally; however, the results obtained can be very detailed thanks to the extensive information provided in every iteration.

References

- [1] P. Garin, M. Sugimoto, Main baseline of IFMIF/EVEDA project, *Fusion Eng. Des.* 84 (2009) 259–264.
- [2] J. Reader, Report on the European Safety and Environmental Assessment for Fusion Power, Eur. Commission. (1995).
- [3] J. Ongena, G. Van Oost, Energy for future centuries - Will fusion be an inexhaustible, safe and clean energy source?, *Fusion Technol.* 37 (2000) 3–15.
- [4] A. Einstein, Ist die Trägheit eines Körpers von seinem Energieinhalt abhängig?, *Ann. Phys.* 323 (1905) 639–641.
- [5] S. Atzeni, J. Meyer-ter-Vehn, *The Physics of Inertial Fusion: Beam Plasma Interaction, Hydrodynamics, Hot Dense Matter*, Oxford University Press, 2004.
- [6] A. Ciampichetti, Tritium Technologies of ITER and DEMO breeding blankets, *Curr. Res. Top. Nucl. Fusion Eng.* (2010).
- [7] J.D. Lawson, Some Criteria for a Power Producing Thermonuclear Reactor, *Proc. Phys. Soc.* (1957).
- [8] D. Meade, 50 years of fusion research, *Nucl. Fusion.* 50 (2010) 014004.
- [9] A. Isayama, Y. Kamada, N. Hayashi, T. Suzuki, T. Oikawa, T. Fujita, et al., Achievement of high fusion triple product, steady-state sustainment and real-time NTM stabilization in high- β ELMy H-mode discharges in JT-60U, *Nucl. Fusion.* 43 (2003) 1272–1278.
- [10] D. van Houtte, Real Time Control of Fully Non-Inductive 6 Minute, 1 Gigajoule Plasma Discharges in Tore Supra, Assoc. EURATOM-CEA. (2003).

References

- [11] M.L. Watkins, The Joint European Torus (JET) pumped divertor results and their significance for the International Thermonuclear Experimental Reactor (ITER), *Phys. Plasmas*. (1994).
- [12] D. Maisonnier, Fusion power plant studies in europe, *Proc. Int. Conf. Nucl. Energy New Eur.* (2007) 1–13.
- [13] IFMIF-EVEDA, IFMIF Intermediate Engineering Design Report, Integr. Proj. Team. (2013).
- [14] H. Kimura, R. Heidinger, T. Muroga, A. Möslang, M. Sugimoto, S. Jitsukawa, et al., IFMIF specifications from the users point of view, *Fusion Eng. Des.* 86 (2011) 611–614.
- [15] IFMIF international team, IFMIF Comprehensive Design Report, (2004).
- [16] R.J. Kurtz, Materials Issues, Gaps and Research Needs, *Harnessing Fusion Power Work*. Los Angeles. (2009).
- [17] S.J. Zinkle, A. Möslang, Evaluation of irradiation facility options for fusion materials research and development, *Fusion Eng. Des.* 88 (2013) 472–482.
- [18] IFMIF international team, IFMIF Conceptual Design Activity (CDA), (1996).
- [19] A. Möslang, International Fusion Materials Irradiation Facility, Conceptual Design Evaluation Report, A Supplement to the CDA, (1999).
- [20] M. Ida, International Fusion Materials Irradiation Facility, Conceptual Design Activity, Reduced Cost Report, JAERI-Tech. (2000).
- [21] H. Takeuchi, Staged Deployment of the International Fusion Materials Irradiation Facility (IFMIF), *Proc. 18th Fusion Energy Conf.* (2000).
- [22] IFMIF Key Element Technology Phase Report (KEP), IFMIF Int. Team. (2003).
- [23] P. Garin, Start of the engineering validation and design phase of IFMIF, *J. Nucl. Mater.* 386-388 (2009) 944–948.
- [24] D. Gex, P.Y. Beauvais, B. Brañas, P. Bredy, P. Cara, J.M. Carmona, et al., Engineering progress of the linear IFMIF prototype accelerator (LIPAc), *Fusion Eng. Des.* 88 (2013) 2497–2501.
- [25] D.J. Smith, *Reliability, Maintainability and Risk, Seventh Edition: Practical Methods for Engineers including Reliability Centred Maintenance and Safety-Related Systems*, Butterworth-Heinemann, 2005.

-
- [26] I. Balan, Adjoint sensitivity analyses procedure of Markov Chains with application on reliability of IFMIF Accelerator-System Facilities, Forschungszentrum Karlsruhe. (2005).
- [27] C. Tapia, J. Dies, A. Calvo, J.C. Rivas, Á. Ibarra, Developing the IFMIF RAM planning, *Fusion Eng. Des.* 84 (2009) 1823–1826.
- [28] R. Brucker, P. Fernández, C. Tapia, J. Dies, J. Abal, J.M. Arroyo, IFMIF RAMI Guidelines, IFMIF Intern. Rep. (2009).
- [29] C. Tapia, J. Dies, J. Abal, V. Pesudo, J.M. Arroyo, A. Ibarra, DATA MANAGEMENT AND DATA CAPTURE METHODOLOGY FROM IFMIF PROTOTYPES, (2010).
- [30] C. Tapia, J. Dies, J. Abal, Á. Ibarra, J.M. Arroyo, Exploration of reliability databases and comparison of former IFMIF's results, *Fusion Eng. Des.* 86 (2011) 2726–2729.
- [31] C. Tapia, J. Dies, V. Pesudo, J. Abal, Á. Ibarra, J.M. Arroyo, IFMIF accelerator: Database, FMEA, fault tree and RAM, *Fusion Eng. Des.* (2011).
- [32] J.M. Arroyo, E. Bargalló, J. Abal, IFMIF RAMI Specifications, IFMIF Intern. Rep. (2012).
- [33] W.T. Weng, Ultra-high intensity proton accelerators and their applications, in: *Proc. 1997 Part. Accel. Conf. (Cat. No.97CH36167)*, IEEE, 1997: pp. 42–46.
- [34] J.D. Gilpatrick, D. Barr, L. Day, K. Kasemir, W. Lysenko, M. Pieck, et al., BEAM DIAGNOSTICS INSTRUMENTATION FOR THE LOW-ENERGY DEMONSTRATION ACCELERATOR (LEDA): COMMISSIONING AND OPERATIONAL EXPERIENCE, (2000) 1717–1719.
- [35] H.V. Smith, T.L. Figueroa, J.D. Gilpatrick, W.P. Lysenko, P.M. Mcgehee, D.E. Rees, et al., COMMISSIONING RESULTS FROM THE LOW-ENERGY DEMONSTRATION ACCELERATOR (LEDA) RADIO-FREQUENCY QUADRUPOLE (RFQ), (2000) 969–971.
- [36] Y. le Tonqueze., IFMIF-EVEDA project, IFMIF-LMJ RAMI Work. (2011).
- [37] L. Hardy, Accelerator Reliability-Availability, KEK Proc. (2003).
- [38] A. Vergara, Reliability analysis for the quench detection in the LHC machine, EPAC2002. (2002) 2445–2447.
- [39] A. BALESTRINO, J. UYTHOVEN, R. FILIPPINI, Dependability analysis of a safety critical system: the LHC beam dumping system at CERN, (2006).

References

- [40] M. Eriksson, Reliability assessment of the LANSCE accelerator system, Royal Institute of Technology, Stockholm, Sweden, 1998.
- [41] C. Commeaux, A. Browman, R.L. Hutson, R.J. Macek, P.J. Tallerico, C.A. Wilkinson, DEVELOPMENT OF A RAMI PROGRAM FOR LANSCE UPGRADE *, (1996) 822–824.
- [42] P.J. Tallerico, Development of a RAMI Model for LANSCE and High Power APT Accelerators, (n.d.).
- [43] M.J. Haire, SNS Document: A PLAN FOR ENSURING HIGH AVAILABILITY FOR THE SPALLATION NEUTRON SOURCE FACILITY, (1999).
- [44] X. Team, XFEL accelerator, (2001).
- [45] A. Blanchard, W. Savannah, R. Company, S.R. Site, J.A. Radder, WSRC-MS-98-00008 RAMI Modeling of Plant Systems for Proposed Tritium Production and Extraction Facilities, (1998).
- [46] A. Fabris, RF Trips at ELETTRA, (1999) 1–17.
- [47] A.G. Alonso, Redundancy of the LHC machine protection systems in case of magnet failures, 2009.
- [48] S. Wagner, G. Guaglio, Balancing safety and availability for an electronic protection system, Eur. Saf. (2008).
- [49] M.A. ALLEN, RELIABILITY AND LIFETIME PREDICTIONS OF SLC KLYSTRONS, (1989) 1–3.
- [50] E.S. Lessner, P.N. Ostroumov, Reliability and Availability Studies in the RIA Driver Linac, Proc. 2005 Part. Accel. Conf. (2005) 443–445.
- [51] E. Ilc, G. Design, W. Wide, S. August, INTERNATIONAL LINEAR COLLIDER REFERENCE DESIGN REPORT ILC Global Design Effort and World Wide Study, (2007).
- [52] U.S. Linear Collider Technology Options Study, U . S . Linear Collid. Steer. Gr. - Accel. Sub-Committee. (2004).
- [53] International Linear Collider Technical Review Committee Second Report, Stanford Linear Accel. Center, Tech. Publ. Dep. (2003).
- [54] T. Himel, J. Nelson, N. Phinney, M. Park, M. Ross, Availability and reliability issues for ILC, (2007) 1966–1969.

-
- [55] S. Henderson, Accelerator and Target Technology for Accelerator Driven Transmutation and Energy Production White Paper Working Group Report, (n.d.).
- [56] P. Pierini, D. Barni, P. Michelato, M. Novati, C. Pagani, R. Paulon, et al., PDS-XADS, Intern. Doc. (2003).
- [57] A. Kozodaev, N. Lazarev, RELIABILITY INCREASE WAYS FOR HIGH-POWER LINACS–ADS DRIVERS, (2000) 942–944.
- [58] J. Biarrotte, C.I.N.P. Ipno, M. Novati, P. Pierini, I. Lasa, S. Mi, et al., Beam dynamics studies for the fault tolerance assessment of the PDS-XADS Linac design, Util. Reliab. High Power Prot. Accel. (2004).
- [59] J. Biarrotte, Reliability & Tolerance Case for ADS, (2011).
- [60] N. Pichoff, Reliability of superconducting cavities in a high power proton linac, 7th EPAC Conf. Vienna. (2000) 2049–2051.
- [61] H.A. Abderrahim, J. Galambos, Y. Gohar, S. Henderson, G. Lawrence, T. Mcmanamy, Accelerator and Target Technology for Accelerator Driven Transmutation and Energy Production, (2010) 1–23.
- [62] A. Mosnier, U. Ratzinger, IFMIF accelerators design, Fusion Eng. Des. 83 (2008) 1001–1006.
- [63] M. Weber, Design Description Document of the AF Ancillary Systems, BA_D_23VJS6. (2013).
- [64] J.M. Carmona, Design Description Document for the IFMIF AF Beam Instrumentation, BA_D_22RB77. (2013).
- [65] B. Brañas, IFMIF Beam Dump Design Description Document, BA_D_23SM4V. (2013).
- [66] P.Y. Beauvais, Design Description Document of the HEBT, BA_D_23NH6A. (2013).
- [67] M. Weber, Design Description Document for the RF POWER SYSTEM, BA_D_23BYCN. (2013).
- [68] F. Orsini, Design Description Document of the IFMIF SRF LINACS, BA_D_23BY8L. (2013).
- [69] I. Podadera, Design Description Document of the Medium Energy Beam Transport line of IFMIF, BA_D_23GDYF. (2013).
- [70] A. Pisent, Design Description Document of the RFQ, BA_D_23VGJY. (2013).

References

- [71] R. Gobin, Design Description Document of the Injector, BA_D_23EHXP. (2013).
- [72] I. Kirpichev, P. Méndez, M. Weber, A. Ibarra, RF power system for the IFMIF/EVEDA prototype accelerator, Proc. of EPAC08. (2008) 496–498.
- [73] S.H.W.R. Alternative, F.O.R. The, I. Dtl, Superconducting HWR alternative, (2008).
- [74] Conclusions of the SRF Linac Review, 23GGQ4_v1_0. (n.d.).
- [75] J.M. Arroyo, A. Ibarra, J. Mollá, J. Abal, E. Bargalló, J. Dies, et al., RAM methodology and activities for IFMIF engineering design, Proc. 2011 Part. Accel. Conf. (2011).
- [76] E. Bargallo, J.M. Arroyo, Accelerator facility RAMI Analysis: First iteration description and first results, IFMIF Intern. Rep. - BA_D_22BVX7. (2011).
- [77] E. Bargallo, J.M. Arroyo, Accelerator facility RAMI Report DDD-II, IFMIF Intern. Rep. - BA_D_2295AZ. (2012).
- [78] E. Bargallo, J.M. Arroyo, Accelerator facility RAMI Report DDD-III, IFMIF Intern. Rep. - BA_D_22VXLA. (2013).
- [79] T. Himel, J. Nelson, N. Phinney, M. Park, M. Ross, Availability and reliability issues for ILC, IEEE Part. Accel. Conf. (2007).
- [80] E. Bargallo, G. Martinez, J.M. Arroyo, J. Abal, P. Beauvais, F. Orsini, et al., RAMI analyses of the IFMIF accelerator facility and first availability allocation between systems, Fusion Eng. Des. (2012).
- [81] A. Blanchard, W. Savannah, R. Company, S.R. Site, B.N. Roy, Savannah River Site Generic Data Base Development, (n.d.).
- [82] T. Pinna, G. Cambi, A. Mazzuca, D.G. Cepraga, Fusion Component Failure Rate Database, (2012).
- [83] P. Limbourg, Multi-objective Optimization of Problems with Epistemic Uncertainty, (2005) 413–427.
- [84] M. Engineering, Introduction to Uncertainty Quantification Gianluca Iaccarino, (n.d.).
- [85] M. Sauvage, N. Pelle, G. Aramburu, IFMIF Cost Model. Tractebel Technical Note, (2012).
- [86] R.C. Creese, P.E. Cce, AACE International. COST ESTIMATE CLASSIFICATION SYSTEM – AS APPLIED IN ENGINEERING , PROCUREMENT , AND CONSTRUCTION, (n.d.).

-
- [87] P. Tallerico, D. Rees, D. Anderson, An Availability Model for the SNS Linac RF System An Availability Model for the SNS Linac RF System *, 836 (n.d.) 1–5.
- [88] A. Lüdeke, Do you believe in Operation Statistics?, in: Accelerator Reliability Workshop, 2011.
- [89] J. Galambos, H. Hotchi, A. Mezger, Summary of the commissioning, operations and performance working group of the HB-2010 workshop, HB2010. (n.d.) 703–705.
- [90] M. Zerlauth, Magnet Powering with zero downtime, (2012).
- [91] S. Belomestnykh, Tutorial on Operational Aspects of Superconducting RF Cavities with Beam, 14th Int. Conf. RF Supercond. (2009).
- [92] A. Hutton, World-Wide Experience with SRF facilities, Part. Accel. Conf. (2011) 2575–2579.
- [93] P. Scherrer, PSI Scientific Report 1998 / Volume VI: Large Research Facilities, (1999).
- [94] J. Galambos, O.R. Tn, T. Koseki, M. Seidel, Commissioning Strategies, Operations and Performance, Beam Loss Management, Activation, Machine Protection, (2008).
- [95] A. Hutton, A. Carpenter, World-Wide Experience with SRF facilities, Jefferson Lab. (2011).
- [96] H. Takei, K. Nishihara, K. Tsujimoto, K. Furukawa, Y. Yano, Y. Ogawa, et al., ADS / P4-06 Estimation of acceptable beam trip frequencies of accelerators for ADS and comparison with experimental data of accelerators ADS / P4-06, (n.d.) 1–9.
- [97] L. Burgazzi, P. Pierini, Reliability studies of a high-power proton accelerator for accelerator-driven system applications for nuclear waste transmutation, Reliab. Eng. Syst. Saf. 92 (2007) 449–463.
- [98] Utilisation and Reliability of High Power Proton Accelerators: Workshop Proceedings, Aix-En-Provence, France, 22-24 November 1999 (Nuclear Science). Peak field studies in the IPHI RFQ , (n.d.).
- [99] T. Powers, P. Kneisel, R. Allen, Arcing Phenomena on GEBAF RF-Windows at Cryogenic Temperatures*, (n.d.) 1645–1647.
- [100] E.F. Daly, D. Curry, J. Musson, G. Myneni, T. Powers, H. Wang, et al., Study of arc-related RF faults in the CEBAF cryomodules, (2004) 890–892.
- [101] J. Hovater, Performance of SRF Systems in Large Scale Applications, Sixth Work. RF Supercond. (1994).

References

- [102] J. Mammosser, S.N.S. Ornl, O. Ridge, Developing facilities for SNS cryomodule performance improvements, (n.d.) 735–739.
- [103] W.J. Schneidert, I.E. Campisi, E.F. Daly, T. Hiatt, J. Hogan, P. Kneisel, et al., Design of the SNS Cryomodule, (2001) 1160–1162.
- [104] C. Pagani, Cryomodule Design, Assembly and Alignment, 12th Int. Work. RF Supercond. (n.d.).
- [105] J. Delayen, Development of a cryomodule for the CEBAF upgrade, (n.d.).
- [106] G. Martinez, Contribution to RAMI assessment of the IFMIF Injector, Univ. Politècnica Catalunya (Master Thesis). (2012).
- [107] S. Nyckees, G. Adroit, O. Delferrière, R. Duperrier, Y. Gauthier, R. Gobin, et al., A NEW BETSI TEST BENCH AT CEA / SACLAY, (n.d.) 117–119.
- [108] R. Gobin, P. Beauvais, A. Ben Ismail, D. Bogard, O. Delferriere, D. De Menezes, et al., ECR Light Ion Sources at CEA / Saclay, (1995).
- [109] Z. Feng, X. Guan, Design of the 2,45 GHz ECRS proton source and LEBT in CPHS, (2009).
- [110] L.D. Hansborough, J.D. Sherman, H.V. Smith, An injector and LEBT for the AAA accelerator, PACS2001. Proc. 2001 Part. Accel. Conf. (Cat. No.01CH37268). 3 (2001) 2096–2098.
- [111] R. Miracoli, Characterization of microwave discharge ion source for high protom beam production in cw and pulsed mode., (2011).
- [112] J.M. Kock, The power supplies switching boards: An efficient system to minimize power supplies failure downtime, Accel. Reliab. Work. (2002).
- [113] L.C. Cadwallader, Vacuum Bellows , Vacuum Piping , Cryogenic Break , and Copper Joint Failure Rate Estimates for ITER Design Use, (2010).
- [114] M.J. Haire, J.C. Schryver, COMPUTATION OF NORMAL CONDUCTING AND SUPERCONDUCTING LINEAR, (2000).
- [115] S. Michizono, Y. Saito, T. Matsumoto, S. Fukuda, S. Anami, RF-windows used at the KEKB linac, 170 (2001) 742–746.
- [116] K.A. Cummings, M.D. Borrego, J. Debaca, J.S. Harrison, M.B. Rodriguez, D.M. Roybal, et al., LIFETIME TESTING 700 MHZ RF WINDOWS FOR THE ACCELERATOR PRODUCTION OF TRITIUM PROGRAM, (n.d.) 974–976.

-
- [117] L.C. Cadwallader, Vacuum system operating experience review for fusion applications, (1994).
- [118] R.G. Carter, RF power generation, Eng. Dep. Lancaster Univ. (2011) 1–35.
- [119] J.K. Young, G. Bolme, J. Lyles, M. Lynch, E. Partridge, D. Rees, LANSCE 201 MHz and 805 MHz RF system experience, PAC2007. (2007) 2412–2414.
- [120] E. Jensen, O. Brunner, LHC High-Power RF System, CWRP 2012. (n.d.).
- [121] O. Brunner, LHC RF: plans for the next long shutdown (2012/13), Work. LHC Perform. (2011).
- [122] E. Jensen, Development and Future Prospects of RF Sources for Linac Applications, 25th Linear Accel. Conf. (2010).
- [123] J.T.M. Lyles, New 201 MHz Radio Frequency Power System for LANSCE, Los Alamos Natl. Lab. Des. Oper. Results. (2011).
- [124] A.K. Mitra, K. Fong, R.E. Laxdal, J. Lu, R. Shanks, Performance of RF amplifiers for ISAC-II medium beta linac operation, Proc. of SRF2007. (n.d.) 685–688.
- [125] R.G. Carter, RF Power Generation I Gridded Tubes and Solid-state Amplifiers, CAS RF Accel. (2010).
- [126] C. Pasotti, M. Boccia, Status and operation of the ELETTRA RF system, 13th ESLS-RF Meet. (2009) 1–29.
- [127] P. Marchand, T. Ruan, F. Ribeiro, R. Lopes, High power 352 MHz solid state amplifiers developed at the Synchrotron SOLEIL, Phys. Rev. Spec. Top. - Accel. Beams. 10 (2007) 1–7.
- [128] J. Jacob, V. Serrière, M. Langlois, G. Gautier, Status of ESRF RF Upgrade: HOM Damped Cavities and Solid State Amplifiers, 19 Th ESLS Meet. 2011. (n.d.).
- [129] M. Weber, E. Bargalló, D. Regidor, RF Power Amplifiers for LIPAc bunchers, IFMIF Doc. (2012).
- [130] M. Weber, B. Brañas, J.M. Méndez., Assessment of the state of development and cost of alternative RF power sources for the IFMIF accelerator. Solid State technology, EFDA Task TW6-TTMI-001. (2007).
- [131] P. Marchand, Commissioning of the SOLEIL 352 MHz RF system, 14th Eur. Synchrotron Light Source Work. (2006).

References

- [132] S. Dillon, W. Gonzales, B. Nobel, J. Reid, Rugged solid-state RF amplifiers for accelerator applications - Design and performance from an industry perspective, Proc. 2011 Part. Accel. Conf. (n.d.).
- [133] O. Piquet, VHDL architecture and synthesis, Eur. Res. Program. Transmutat. High Lev. Nucl. Waste an Accel. Driven Syst. (2008).
- [134] I. Bylinskii, K. Fong, J. Lu, A.K. Mitra, C. Owen, RF amplifier choice for the ISAC superconducting linac, 2007 IEEE Part. Accel. Conf. (2007) 3798–3800.
- [135] M. Weber, P. Méndez, I. Kirpichev, M. Falagan, A. Soleto, A. Ibarra, Preliminary study on alternative RF power systems for superconducting half-wave resonators in IFMIF accelerator, (2007).
- [136] P.J. Sureda, Adaptation of the Availsim software to the IFMIF RAMI requirements, Univ. Politècnica Catalunya (Final Degree Proj. (2013).

Acronyms

AF: Accelerator Facility

APPM: Atomic Parts Per Million

ADS: Accelerator Driven System

ANL: Argonne National Laboratory

BA: Beam availability

BE: Beam effectiveness

BPM: Beam Position Monitor

C: Criticality

CC: Cryomodule Century

CDA: Concept Design Activity

CDR: Comprehensive Design Report

CEA: Commissariat à l'Énergie Atomique

CIEMAT: Centro de Investigaciones Energéticas, Mediambientales y Tecnológicas

CM: Cryomodule

CW: Continuous Wave

DDD: Design Description Document

DESY: Deutsches Elektronen-Synchrotron

dpa: displacements per atom

DTL: Drift Tube Linac

ECR: Electron Cyclotron Resonance

EF: Error Factor

EMU: Emittance Meter Unit
ESRF: European Synchrotron Radiation Facility
ESS: European Spallation Source
eV: electron-volt
EVEDA: Engineering Validation and Engineering Design Activities
FA: Functional Analysis
FC: Fraction contribution
FEEL: Fusion Energy Engineering Laboratory
FGA: Four Grid Analyzer
FMEA Failure Modes and Effects Analysis
FMECA: Failure Modes, Effects and Criticality Analysis
FNAL: Fermi National Accelerator Laboratory
Fpy: Full power year
FR: Failure Rate
FT: Fault Tree
He: Helium
HA: Hardware Availability
HEBT: High Energy Beam Transport
HERA: Hadron Electron Ring Accelerator
HOM: High Order Modes
HWR: Half-Wave Resonators
IAEA: International Atomic Energy Agency
IEA: International Energy Agency
IFMIF: International Fusion Materials Irradiation Facility
IIEDR: Intermediate IFMIF Engineering Design Report
ILC: International Linear Collider
INEEL: Idaho National Engineering and Environmental Laboratory
IPHI: High-Intensity Proton Injector (Injecteur de Protons Haute Intensité)
ITER: International Thermonuclear Experimental Reactor

JAERI: Japan Atomic Energy Research Institute
J-PARC: Japan Proton Accelerator Research Complex
JKJ: Joint KEK-JAERI
KEK: High Energy Accelerator Research Organization (Kō Enerugī Kasokuki Kenkyū Kikō)
KEP: Key Element Technology Phase report
KOMAC: KOrea Multi-purpose Accelerator Complex
LANL: Los Alamos National Laboratory
LANSCE: Los Alamos Neutron Science Center
LEBT: Low Energy Beam Transport
LEDA: Low Energy Demonstration Accelerator
LEP: Large Electron-Positron Collider
LHe: Liquid Helium
Li: Lithium
LINAC: linear accelerator
LIPAc: Linear IFMIF Prototype Accelerator
LNS-INFN: Laboratori Nazionali del Sud - Istituto Nazionale Fisica Nucleare
M: Maintainability
MDT: Mean Down Time
MeV: Megaelectron-volt
MTBF: Mean Time Between Failures (or Before Failure)
MTBM: Mean Time Between Maintenance
MTTR: Mean Time To Repair
MPS: Machine Protection System
O: Occurrence
PBS: Plant Breakdown Structure
PC: Personal computer
PLC: Programmable logic controller
PPS: Personnel Protection System
Q (t): Time dependant unavailability

Q: Unavailability

R: Reliability

RAMI: Reliability, Availability, Maintainability and Inspectability

RBD: Reliability Block Diagram

RF: Radio frequency

RFPS: Radio frequency power supply

RFQ: Radiofrequency Quadrupole

SCL: Superconducting Cryogenic Linac

SILHI: High Intensity Light Ion Source (Source d'Ions Légères a Haute Intensités)

SLAC: Stanford Linear Accelerator Center

SLC: Stanford Linear Collider

SPL: Superconducting Proton Linac

SNS: Spallation Neutron Source

SPL: Superconducting Proton Linac

SRF: Superconducting Radio-Frequency

TJNAF: Thomas Jefferson National Accelerator Facility

TRASCO: TRAnsmutation SCORia